



SCUBA SERVICE

TOOLS



04/2026

CATALOG

INTRODUCTION

Online store for specialised scuba equipment service tools. Producing hi quality regulator repair tools and testing equipment. Making sure the scuba technician can trust his tools and concentrate on the actual service of the equipment.

All specialised scuba service tools are manufactured and tested in house and do not leave our shop after undergoing severe testing during actual service.

We deliver our [specialised scuba tools](#) and [tool kits](#) world wide to a wide range of customers from dive shops to liveaboards to individual scuba repair technicians.

Visit our [online store](#) and pick your tools out of a wide range of products, ranging from specialised scuba tools to standard tools that should be present in every dive technicians shop. We also offer [scuba test equipment](#) from a basic to a professional level, these panels are used at a daily basis in dive shops all round the world.

At Scuba Service Tools, we produce the highest quality [specialised scuba tools](#) so your service time gets more efficient and less frustrating.

We are always more than happy to provide technical advice and accommodate for special service needs or requests. For more details please visit our website scubaservicetools.com or send us an email at info@divingondemand.com

We can also be reached by phone [+31651997943](tel:+31651997943) during normal business hours (CET 09:00 till 17:00) or by using our [contact form](#).

Looking for a tool that is not in our webshop, no problem just send us a detailed drawing of your tool together with an explanation on how you would like to use the tool. If after our consideration your design finally ends up in our webshop you will be send a free sample of this tool.

TABLE OF CONTENTS

APEKS tools	3
SCUBAPRO/TUSA tools	9
POSEIDON tools	21
MARES tools	24
AQUALUNG tools	30
SHERWOOD tools	35
CRESSI tools	38
HOLLIS tools	41
ATOMIC tools	43
OCEANIC tools	46
SEAC tools	48
SUUNTO tools	50
UNIVERSAL tools	52
TOOL-KITS	62
INSTRUMENTS	69
FILL PANELS	85
STANDARD TOOLS	88
SHIPPING	98

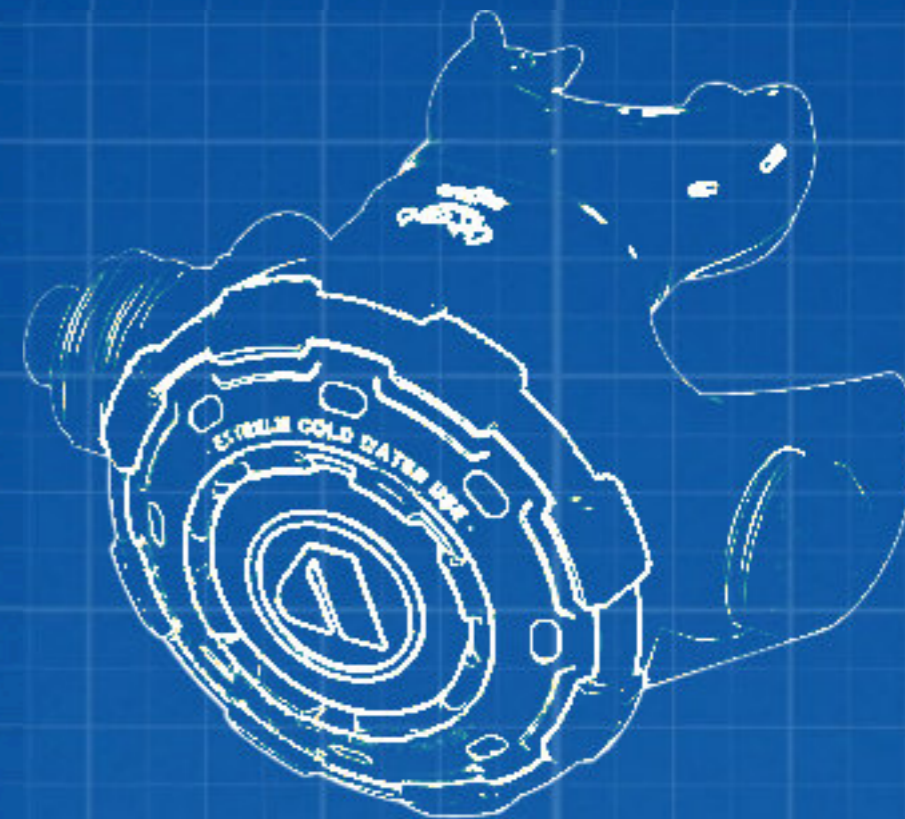

When you spend money on an Apeks regulator service kit, you also want to be sure that all parts are correctly placed in your Apeks regulator. Before starting the service of your Apeks flight regulator or your trusted dry-suit, take a look at our collection of Apeks diving tools. For example, we offer cover tools for the current Apeks MTX-R and the Apeks DB4, but also many different lever height setting tools for older and of course the very latest models.

To let your customer start his next dive with peace of mind, it is important to deliver the set to factory specs, this is easiest with one of our test benches which can be found on the instruments page.

APEKS tools



Apeks MTX-R and MTX cover tool

The second stage cover tool for Apeks MTX and MTX-R is, without doubt, the ideal tool to open the covers of both Apeks second stage.

SKU: 1000-SST-066

€15,00



Apeks seal cap socket for MTX-R and DB-4

The Environmental seal cap socket for the Apeks MTX-R and DB4 first stage is used to remove and install the environmental seal cap (Apeks part# AP2010) on top of the Apeks MTX-R and the Apeks DB-4 first stage. The tool incorporates a 1/2" Ratchet drive so it can be removed and closed with a torque or a socket

SKU: 1000-SST-065

€14,00



Apeks XTX cover tool - old model

The Apeks XTX cover tool - the old model will assist in the removal and installation of the second-stage cover on the old model Apeks XTX.

SKU: 1000-SST-039

€16,00



Apeks drysuit dump valve tool

The dump valve tool for Apeks drysuits tool is used to remove the cap of the Apeks low-profile automatic dump valve.

SKU: 1000-SST-060

€25,00



Apeks XTX cover tool - new model

The cover tool for Apeks XTX - the new model will assist in the removal and installation of the second-stage cover on the new model Apeks XTX.

SKU: 1000-SST-037

€16,00



Apeks Flight and XL4 tool

The diaphragm retainer tool for Apeks Flight scuba regulator (identical to the Apeks AT71 tool) can be used in 2 different ways in the first and the second stage of the Apeks flight regulators. But also for opening the second stage membrane locking ring in the Apeks Flight and XL4 second stage.

SKU: 1200-SST-010

€22,00



Apeks cover tool for AT, T, TX, and ATX

The cover tool for Apeks AT, T, TX and ATX will assist in the removal and installation of the second-stage cover of these Apeks second stage during the Apeks regulator service.

SKU: 1300-SST-001

€19,00



Apeks balance chamber O-Ring tool

The HP balance plug O-ring installation tool for Apeks first stage will assist the technician when placing the O-ring on the Apeks balance chamber

SKU: 1000-SST-005

€6,00



Apeks 19mm yoke nut socket

This 19mm Apeks yoke nut socket fits on all Apeks yoke (INT) first-stage regulators (except the Flight). On this Apeks tool located at the top of the socket is an 8mm hex connection which is easily accessible with an 8mm long hex key with a connection to a 3/8" socket wrench.

SKU: 2000-SST-016

€19,99



O-Ring tool for second stage barrel

The O-ring installation assist tool for Aqualung and Apeks ballanced scnd stage barrel ensures that the O-rings from the Apeks service kit are not overstretched. By placing the tool over the barrel, the O-ring can easily be slid over it.

SKU: 1000-SST-014

€7,00



Apeks drysuit inflator tool

The inflator tool for Apeks drysuits is used to separate the valve body of the Apeks low-pressure swivel inflator valve from your drysuit so you can reach the o-rings for inspection inside the swivel body.

SKU: 1000-SST-008

€12,00



Apeks TX lever height setting tool

The lever height setting tool for Apeks TX second stage is used to verify the lever height during the final set-up of Apeks TX 20, 40, and, 50-second stages.

SKU: 1000-SST-022

€14,99



Apeks drysuit valve back plate tool

The back nut tool for Apeks drysuits is used to remove and install the low-profile automatic dump valve and low-profile swivel inflator from and onto the Apeks drysuits. The tool can be used together with a 1/2" Ratchet in case more torque is needed.

SKU: 1200-SST-021

€23,00

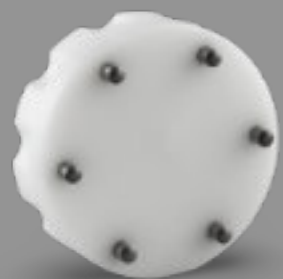

Apeks TX100 lever height setting tool

The lever height setting tool for Apeks TX100 second stage is used to verify the lever height during the final set-up of the Apeks TX100 second stage.

SKU: 1000-SST-023

€14,99



Apeks aluminium C-spanner

Custom-made Apeks aluminium C-spanner fits all Apeks first stage models. It is used to remove and install environmental end caps as well as diaphragm clamps. The C-spanner size is 1,7 inches (43,18mm) The Apeks aluminium C-spanner is fitted with a 3mm hardened steel tip

SKU: 3000-SST-004

€24,00



Apeks ATX/MTX/MTX-R lever height setting tool

The lever height setting tool for Apeks ATX/MTX/MTX-R second stage is used to verify the lever height during the final set-up of the Apeks ATX/MTX/MTX-R second stage.

SKU: 1000-SST-020

€14,99

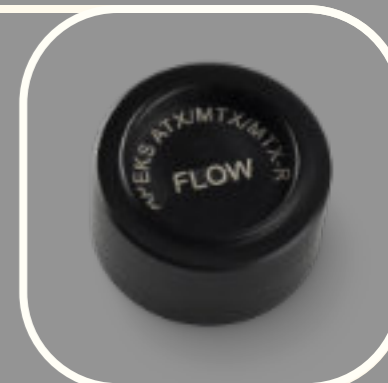

Apeks XTX lever height setting tool

The lever height setting tool for the new Apeks XTX second stage is used to verify the lever height during the final set-up of the Apeks XTX second stage. The tool has two sides, a flow side, and a no-flow side.

SKU: 1000-SST-042

€14,99



Apeks Flight lever height setting tool

The lever height setting tool for the Apeks XL4 second stage (identical to the Apeks AT75 tool) is used to verify the lever height during the final set-up of the Apeks XL4 second stage after the Apeks regulator service.

SKU: 1000-SST-031

€21,00



Apeks XTX (old model) lever height setting tool

This lever height setting tool for old Apeks XTX second stage is used to verify the lever height during the final set-up of the old model Apeks XTX second stage. The tool has two sides a flow side and a no-flow side.

SKU: 1000-SST-043

€15,00

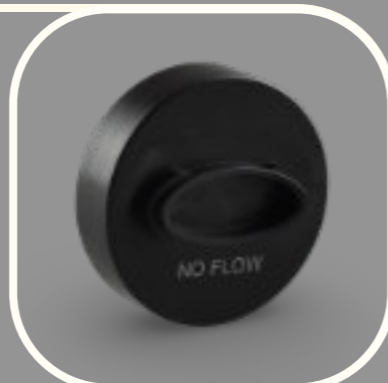

Apeks valve seat tool for removable HP seats

The Apeks valve seat tool for removable HP seats is used to remove and install the HP seats of the Apeks XTX200, ATX200, Tungsten, Black Pearl, and Black Sphire.

SKU: 1200-SST-011

€19,00

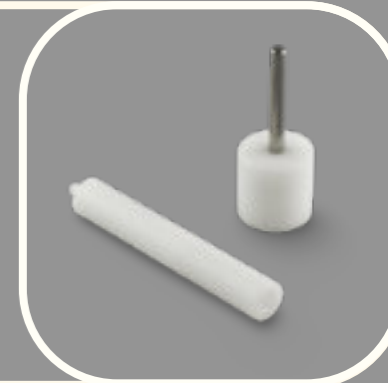

Apeks Flight heavy duty composite diaphragm ret. tool

The Apeks Flight heavy-duty composite diaphragm retainer tool can be used when more than 20Nm of torque is required due to severe corrosion of the first stage.



SKU: 1200-SST-037

€29.00

Apeks valve seat tool for removable HP seats

The Apeks valve seat tool for removable HP seats is used to remove and install the HP seats of the Apeks XTX200, ATX200, Tungsten, Black Pearl, and Black Spphire.



SKU: 1200-SST-011

€20.00

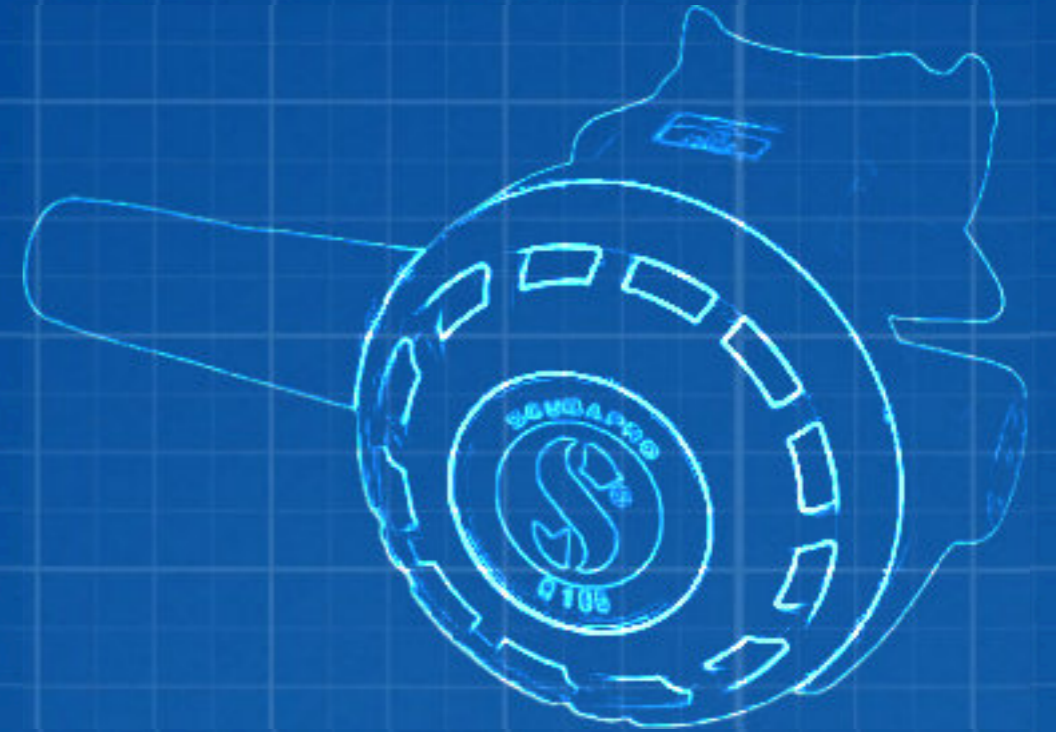

Whether you have your Scubapro regulator service performed annually or occasionally, you always want to be sure that the service center has special Scubapro tools to adjust your regulator all the way to spec. At Scuba Service Tools we make a Scubapro tool for almost every Scubapro regulator. take a look around at your leisure, there is a Scubapro service tool or complete Scubapro service kit for every job.

Scubapro R105 Cover tool

Opening and closing the Scubapro R105 second stage cover can be done with ease using this cover tool.



SKU: 1000-SST-071

€19,00

Scubapro D420 flow vane ring tool

This tool is the best tool for installing and removing the Scubapro D420 flow vane ring.



SKU: 1200-SST-019

€15,00

Scubapro S270 Cover tool

To make it easier to open the Scubapro S270 second stage cover, we have designed the Scubapro S270 cover tool.



SKU: 1000-SST-070

€16,00

Scubapro Hydros BCD color kit tool

The three-pin socket for the Scubapro Hydros Pro BCD color kit is used to attach the grommet and nut (Scubapro part number: 21.782.005) of the Scubapro Hydros color kits.



SKU: 1200-SST-016

€13,00

Scubapro G260 Carbon Cover tool

Opening and closing the Scubapro G260 Carbon second stage cover can be done with ease using the cover tool for the Scubapro G260 carbon second stage.



SKU: 1000-SST-069

€15,00

3/16" extra long hex key

3/16" extra long hex key used for adjusting the orifice of the Scubapro AIR-2 and the Tusa Duo-AIR regulators.

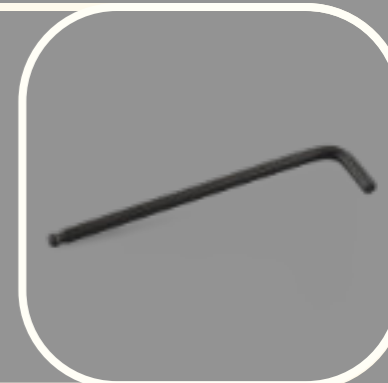

SKU: 1800-SST-050

€14,00

Scubapro splined wrench

During the frequent use of this tool in our own service center, we have noticed that the splines in the aluminum and plastic version of this tool wear slowly and therefore no longer fit perfectly around the hose nut. To solve this problem, we redesigned the tool in a 304 stainless steel finish

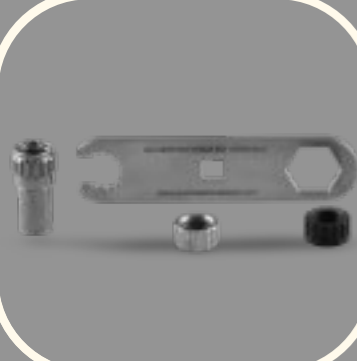

SKU: 2000-SST-023

€14,99

Scubapro AIR2 cover ring tool

This Scubapro tool is used to open and close the Scubapro AIR2 cover ring and can be used for generations 4th and 5th.

In our collection of specialized tools for Scubapro, you will also find the Scubapro scuba tools for the previous generations of AIR2.



SKU: 3000-SST-021

€15,00

Scubapro D420 flow vane plug tool

Scubapro tool for opening the Scubapro D420 flow vane plug. Place the tool with both hardened stainless pins in the two round openings of the D420 flow vane plug.

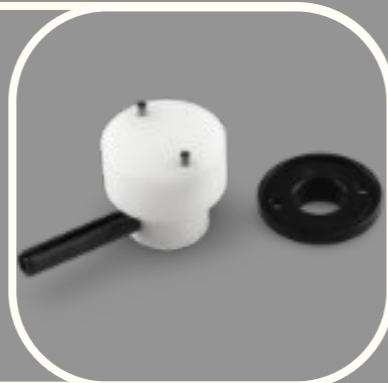

SKU: 1200-SST-020

€14,00

Scubapro AIR2 5th gen. inflator plug tool

This Scubapro AIR2 5th generation inflator plug scuba tool is used to open and close the Scubapro AIR2 5th generation inflator plug.



SKU: 3000-SST-027

€9,50

Scubapro AIR2 5th gen. exhaust spider tool

This exhaust spider tool for the Scubapro AIR2 5th generation tool is used to open and close the Scubapro AIR2 5th generation exhaust spider together with the one-way valve.



SKU: 3000-SST-025

€14,50

Scubapro 25mm yoke nut socket

This yoke nut socket 25mm for Scubapro first stage with extra-thin walls fits on all Scubapro yoke (INT) first-stage regulators. Also fits on several Cressi first stage. Located at the top of the socket is an 8mm hex connection which is easily accessible with an 8mm long hex key with a connection to a 3/8" or a 5/16" hex



SKU: 2000-SST-014

€19,99

Scubapro AIR2 5th gen inflator stem o-ring installation

This tool is used to slide the two o-rings from the Scubapro AIR2 5th generation inflator stem easily in place without damaging them.



SKU: 3000-SST-029

€5,00

Scubapro 28mm retainer ring socket

This socket is used to open and close the 28mm diaphragm retainer ring on the Scubapro MK17 Evo and the MK19 Evo first stage. And can be used in combination with an 8mm long hex key with a connection to 3/8".



SKU: 2000-SST-012

€22,00

Scubapro AIR2 5th gen inflator stem tool

This tool is used to hold the round recessed part under the Scubapro AIR2 5th generation inflator button.



SKU: 3000-SST-028

€12,00

Scubapro R295 and R395 Cover tool

The Scubapro R295 and R395 cover tool is a very useful scuba tool for opening the Scubapro R295 and R395 second-stage cover. By inserting the formed part on the top of the tool into the purge button, the cover of the second stage can be easily opened after removing the locking pin.



SKU: 1000-SST-017

€19,00

Scubapro AIR2 inlet tube o-ring installation tool

This Scubapro AIR2 inlet tube o-ring installation tool is used to slide the thick o-rings from the Scubapro AIR2 easily in place without damaging them during the Scubapro regulator service.



SKU: 3000-SST-020

€7,00

Scubapro R195 Cover tool

The second stage cover tool for Scubapro R195 will assist in opening the second stage cover of the Scubapro R195. The many recesses grip into the second stage cover ring and ensure a smooth opening of the entire cover.



SKU: 1000-SST-063

€16,00

Scubapro AIR2 poppet assembly assist tool

This very handy scuba tool is used to tension the spring in the Scubapro AIR2 poppet assembly so it is easier to install the lever, washer, and nut on top of the poppet assembly.



SKU: 3000-SST-026

€11,00

Scubapro C370 and C350 Cover tool

The cover tool for the Scubapro C370 and C350 is the ideal tool for opening the Scubapro C370 and the C350 second-stage cover.



SKU: 1000-SST-036

€21,00

Scubapro C200 and C300 cover tool

The cover for Scubapro C series will assist in opening the second stage cover of the Scubapro C200 and C300. The three recesses grip into the second stage cover ring and ensure a smooth opening of the entire cover.

SKU: 1000-SST-057

€15,00



Scubapro S600 old model cover tool

The Scubapro S600 old model cover tool assists the technician in opening the second stage cover of the Scubapro S600 (1st and 2nd generation).

SKU: 1000-SST-018

€19,00

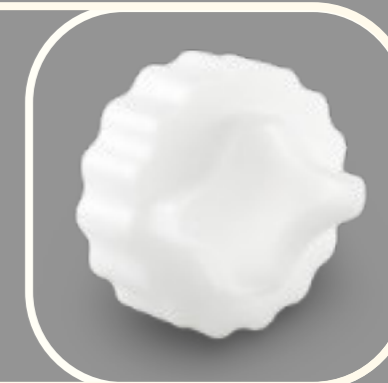

Scubapro S560 and S360 cover tool

The Scubapro S560 and S360 cover tool is used to open the Scubapro S560 second stage cover during the Scubapro regulator service.

By placing the tool over the second stage cover the 3 recesses will lock into the cover ring.

SKU: 1000-SST-035

€16,00



Scubapro cover tool for R095 R380, R390, S550, G500 /

When removing the cover of several Scubapro second stages including the R095 (old model), R380, R390, S550, and G500 / Tusa S60 this tool is the perfect solution.

SKU: 1000-SST-059

€17,00



Scubapro R095 new model cover tool

The second stage cover tool for Scubapro R095 will assist in opening the second stage cover of the Scubapro R095 (new model). The two recesses grip into the second stage cover ring and ensure a smooth opening of the entire cover.

SKU: 1000-SST-044

€16,00



Scubapro R290 cover tool

The Scubapro R290 cover tool is used to open and close the second-stage cover of the Scubapro R290.

Lots of times the cover of the 2nd stage is screwed on too tight or the technician is unable to remove it because of dirty threads this tool will assist in removing the cover in an easy way.

SKU: 3000-SST-030

€16,00



Scubapro G260 cover tool

The second stage cover tool for the Scubapro G260 tool will assist in opening the second stage cover of the Scubapro G260

The many recesses grip into the second stage cover ring and ensure a smooth opening of the entire cover during your Scubapro regulator service.

SKU: 1000-SST-033

€16,00



Scubapro Cover tool for R190, G250, G200, and M5

The cover tool for Scubapro R190, G250, G200, and M5 will assist in removing the cover of these Scubapro second stage.

SKU: 1300-SST-032

€10,00



Scubapro S600 S620Ti cover tool

The cover tool for the Scubapro S620 Ti will assist in opening the second stage cover of the Scubapro S600 (3rd and 4th generation) as well as the S620 Ti and Black tech.

SKU: 1000-SST-032

€16,00



Scubapro MK2 Evo high pressure seat tool

The Scubapro MK2 Evo high pressure seat tool is used to remove and install the high-pressure seat from the body of the Scubapro MK2 Evo.

SKU: 1200-SST-013

€12,00

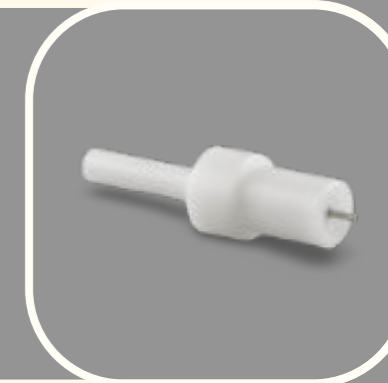

Scubapro R-series case recovery tool

The valve body holder tool for Scubapro second stage can be used to save the plastic housings of the Scubapro R-series 2nd stage regulators when the valve body and the valve housing are badly corroded.



SKU: 2000-SST-008

€10,00

Scubapro AIR2 exhaust spider tool

The Scubapro AIR2 exhaust spider tool for the 3rd and 4th generation is used to open and close the Scubapro AIR2 (3rd and 4th generation) exhaust spider together with the one-way valve.



SKU: 1000-SST-053

€9,00

Scubapro flow vane removal tool

The flow vane remover tool for Scubapro second stage is used to remove the flow vane from the second-stage body.



SKU: 2000-SST-007

€9,00

Scubapro first stage piston tool

The piston bullet for Scubapro first stage fits on the Scubapro MK5, MK10, MK20, and MK25 first stage.

It helps slide the piston assembly during the Scubapro regulator service through the first stage body while protecting the critical knife edge and preventing the o-ring from damage.



SKU: 4000-SST-002

€7,00

Scubapro balance chamber tool

The top of the balance chamber cover is most of the time too deep to be able to open with a normal wrench, therefore we have made the balance chamber tool for the Scubapro MK11, Scubapro MK16, Scubapro MK18, and the Tusa R400 first stage.



SKU: 2000-SST-002

€15,00

Scubapro MK17 combined HP seat tool

The high-pressure seat extractor for Scubapro MK17 first stage is used to remove and install the HP seat of the Scubapro MK16, MK17, MK11, and Tusa RS460 and RS790 first stage.

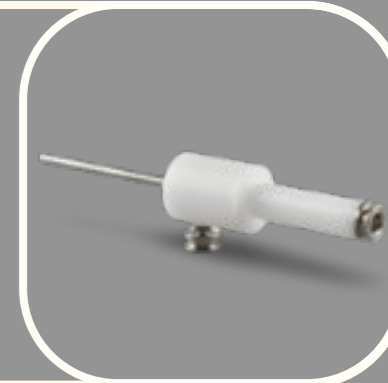

SKU: 1200-SST-002

€9,00

Scubapro AIR2 inflator plug tool

The Scubapro AIR2 inflator plug tool for the 2nd, 3rd, and 4th generations is used to open and close the Scubapro AIR2 inflator plug.



SKU: 1000-SST-051

€7,00

Scubapro bushing tool

Some of Scubapro's first stages use a bushing arrangement to help with the movement of the piston during diving. Installing these bushing rings and the small O-ring in between them is made easy when you use the bushing tool for Scubapro during the Scubapro regulator service.

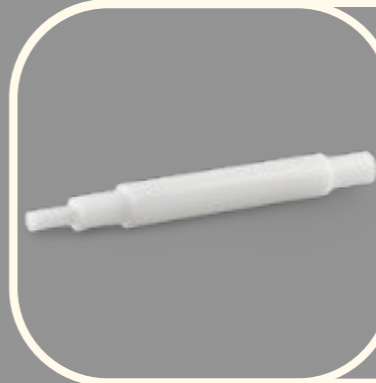

SKU: 1000-SST-034

€12,99

Scubapro AIR2 inflator stem o-ring installation tool

The Scubapro AIR2 inflator stem o-ring installation tool is used to slide the o-rings from the Scubapro AIR2 (2nd, 3rd, and, 4th generation) inflator stem easily in place without damaging them.



SKU: 1000-SST-045

€6,00

Scubapro BCD tool

The Scubapro BCD tool is during the Scubapro equipment service to open and close all valves attached to Scubapro BCD.

Because of the big square opening in the middle, it can also be used to open the valve connected to the inflator assembly on top of the jacket



SKU: 1200-SST-035

€20,00

Scubapro MK5 internal O-ring tool set

The Scubapro MK5 internal O-ring tool set ables the technician to put an O-ring into the main body of a Scubapro MK5 first stage in a matter of seconds.

SKU: 1000-SST-007

€13,00



DIN retaining knob tool

The DIN retaining knob tool is used to get the DIN retaining knob o-ring over the sharp threads withoThe inflator plug tool for the Scubapro BPI inflator is used to open and close the Scubapro BPI inflator plug.

SKU: 1000-SST-028

€5,00



Scubapro MK10 internal O-ring tool set

Ever tried to put a new O-ring into the main body of a Scubapro MK10 first stage? With the Scubapro MK10, internal O-ring tool set the job is done in a matter of seconds.

SKU: 1000-SST-026

€13,00



Scubapro drift tool

Use the Scubapro drift tool to make the removal and installation of the high-pressure seats as well as the small backup O-ring and washer in the body of the Scubapro MK11, MK16, MK17, MK18 / Tusa R400 a piece of cake..

SKU: 1000-SST-027

€9,00



Scubapro second stage plug tool

Use the Scubapro second-stage plug tool to open and close the Scubapro second-stage plug during the Scubapro regulator service.

SKU: 1200-SST-033

€7,00



Scubapro BPI inflator plug tool

The inflator plug tool for the Scubapro BPI inflator is used to open and close the Scubapro BPI inflator plug.

Scubapro part # 21.610.000

SKU: 3000-SST-032

€9,50



Scubapro D series tool

The tool for Scubapro D-series second stage will open the big black and small silver nut located on the outside of the second-stage regulator body of the Scubapro D300, D350, and D400.

SKU: 1200-SST-059

€15,00



Scubapro BPI inflator stem tool

The inflator stem tool for Scubapro BPI is used to hold the round recessed part under the Scubapro BPI inflator button.

Hold the recessed part with the tool and at the same time loosen or fasten the screw on the other end.

SKU: 3000-SST-031

€12,00



Scubapro seat retainer t-handle socket

The seat retainer T-handle socket for Scubapro MK5 and MK10 is used for the easy removal and installation of the seat retainer found on the Scubapro models MK5, MK6, MK7, MK10, and MK20 first stage.

SKU: 1200-SST-001

€14,00



Scubapro MK19 EVO balance chamber tool

This tool is used to open and close the Scubapro MK19EVO balance chamber. Normally the tool is used as a hand tool, but if the balance chamber is heavily corroded it can also be used in combination with a 17mm or 11/16" socket.

Scubapro part # 107.191.02

SKU: 2000-SST-020

€15,00



Scubapro Mk11 diaphragm retainer torque C-spanner tool

The Scubapro Mk11 diaphragm retainer torque C-spanner tool is used to tighten the retainer of the Mk11 first-stage regulator to the specified torque of 35 Nm.

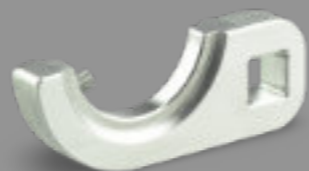

SKU: 1200-SST-032

€19.99

Scubapro X650 second-stage lever tool

The Scubapro X650 second-stage lever tool is used for the installation and removal of the lever of the Scubapro X650 second stage.



SKU: 1200-SST-040

€9,00

Scubapro D420 cover tool

The Scubapro D420 cover tool is used to remove and install the retaining ring of the Scubapro D420.

Before using this tool, the "Pin button 01075421" and the "purge button 11420036" have to be removed.

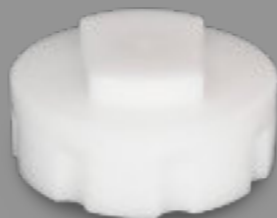

SKU: 1200-SST-044

€16,00

Scubapro MK17/MK19 evo dry chamber + diaphragm retainer socket

Designed for Scubapro MK17 and MK19 Evo first-stage regulators, this dual-purpose tool facilitates the assembly and disassembly of both the diaphragm retainer and the dry chamber.



SKU: 1200-SST-042

€35,00

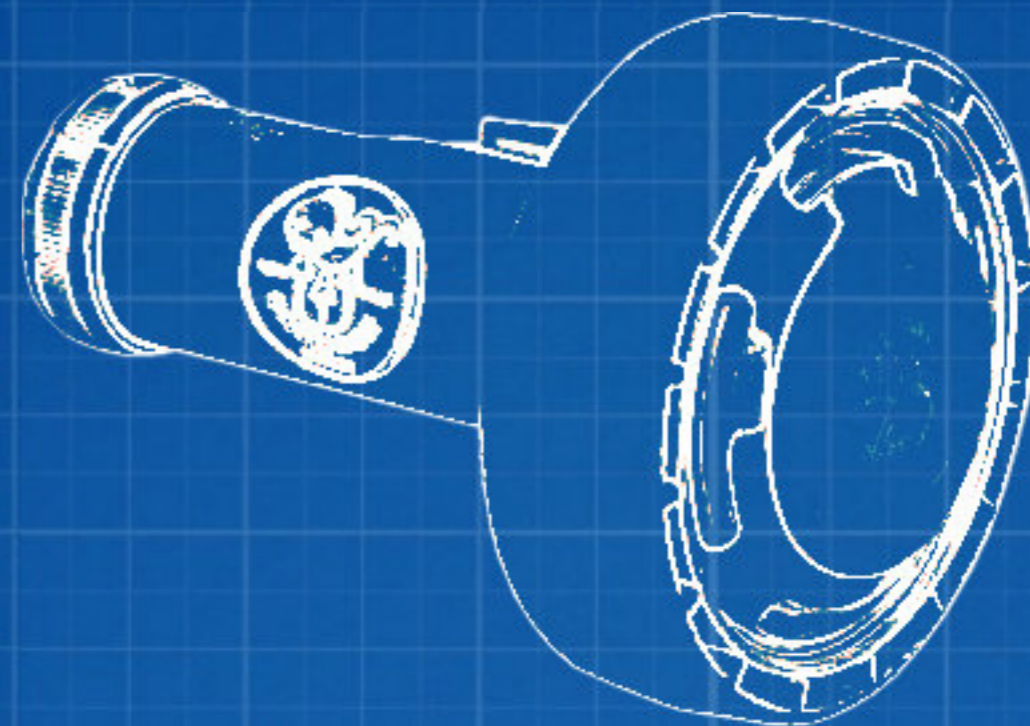

As Poseidon distinguishes itself in the diving products they bring to the market, we try to distinguish ourselves through the service and quality of our Poseidon regulator service tools. Therefore our products are made of sustainable materials and are used by major dive resorts as well as in the small dive shop around the corner servicing Poseidon regulators.

In our shop, you will find, among other things, scuba tools for an extensive range of Poseidon regulators.

POSEIDON tools



Poseidon Cyklon second-stage drift tool

The drift tool for the Poseidon Cyklon second stage makes the assembly of the valve housing of the Poseidon Cyklon second stage much easier

SKU: 1000-SST-024

€9,00



Poseidon Cyklon locking nut screw tool

The locking nut screw tool for Poseidon Cyklon 300 first stage is used for opening and closing the small locking nut screw on top of the filter on the Poseidon Cyklon 300.

SKU: 1200-SST-005

€7,00



Poseidon Jetstream First stage tool set

This tool is used to correctly assemble the internal parts of your Poseidon Jetstream first stage (model; 3720 and 3790).

SKU: 1000-SST-004

€21,00



Poseidon valve housing tool

The Poseidon valve housing tool is used for the installation of the O-ring back into the valve housing of the Poseidon Jetstream and Xstream second stages.

SKU: 1000-SST-002

€17,00



Poseidon first stage socket

Use the 27mm socket for Poseidon first stage during the installation and removal of the top covers of the Poseidon Jetstream, Poseidon Triton, and the Poseidon Cyklon first stages.

SKU: 3000-SST-002

€39,00



Poseidon Cyklon 5000 valve seat and drift tool-set

The Poseidon Cyklon 5000 valve seat and drift tool-set consists of a valve seat removal tool and a drift tool.

This set can be used with the service of the Poseidon Cyklon and Jetstream first-stage regulators.

SKU: 1200-SST-003

€21,00



Jetstream and Xstream valve housing tool

The Jetstream and Xstream valve housing tool is used for the disassembly and assembly of the valve housing of the Poseidon Jetstream and Xstream second stages.

SKU: 3000-SST-009

€39,00



Poseidon Jetstream and Xstream leak testing tool

The Poseidon Jetstream and Xstream leak testing tool enables a LP valve housing assembly to be easily pressurised and checked for leaks in a water bath outside the regulator body.

SKU: 1200-SST-031

€19,00



Poseidon Cyklon valve seat tool

The valve seat tool for Poseidon Cyklon first stage is used for the removal and installation of the Teflon valve seat of the Poseidon Cyklon first stage.

SKU: 1210-SST-001

€18,00

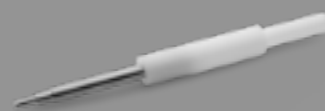

Poseidon Xstream first stage socket

The Poseidon Xstream first-stage socket is used to open and close the upper pin guide of Poseidon Xstream first stage regulator.

Because of the 3/8" ratchet opening a torque wrench can be used during reassembly after service. The base can also be clamped in a vise and therefore used as a base to hold the pin guide.

SKU: 1200-SST-047

€16,00

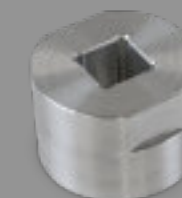

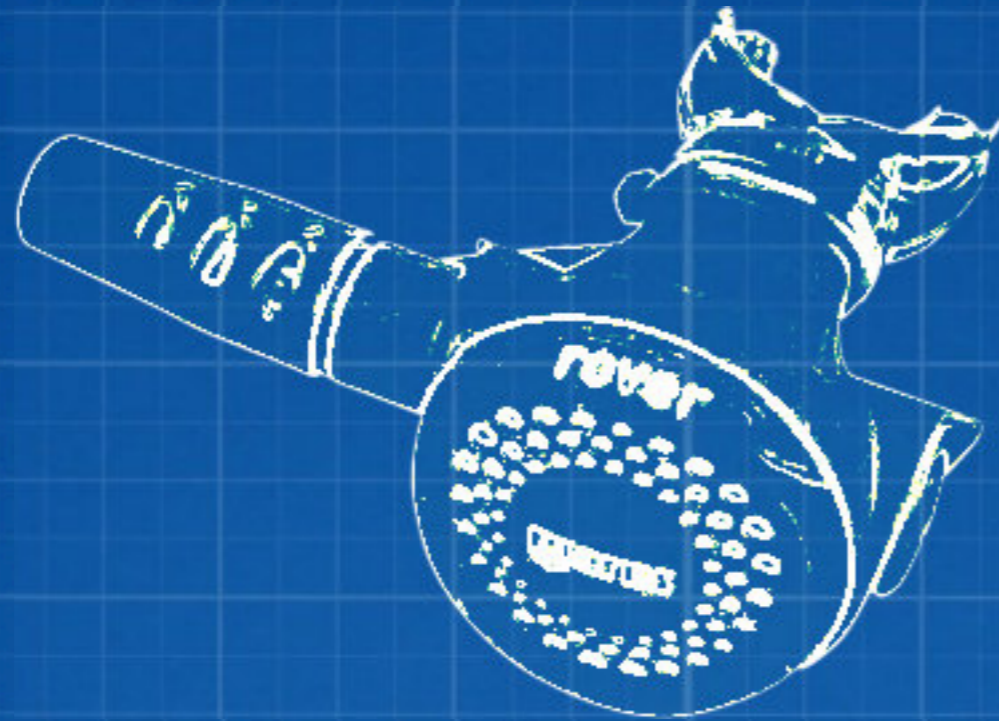

Mares CWD tool for 82X first stage regulator

The Mares CWD tool for 82X first stage regulator is designed to open and close the top ring of the 82X CWD dry kit so that the black diaphragm can be replaced during service.



SKU: 2000-SST-022

€19,00

Mares Rover cover tool



Opening and closing the mares Rover second stage cover can be done with ease using the cover tool for Mares Rover second stage. Place the three recesses in the openings of the Mares second stage cover, then open or close the cover using the ribbed handle.

SKU: 1000-SST-055

€17,00

Mares Prestige cover tool

Opening and closing the mares Prestige second stage cover can be done with ease using the cover tool for Mares Prestige second stage. Place the two ribs in the openings of the Mares second stage cover, then open or close the cover using the ribbed handle.



SKU: 1000-SST-056

€17,00

Mares Fusion cover tool



The Mares Fusion cover tool is used to open the cover of the Mares Fusion second stage by sliding it over and locking the four tips into the recesses of the second stage cover.

SKU: 1000-SST-040

€18,00

Mares Loop cover tool

Opening and closing the mares Loop second stage cover can be done with ease using the cover tool for Mares Loop second stage. Place the two recesses in the openings of the Mares second stage cover, then open or close the cover using the ribbed handle.



SKU: 1000-SST-048

€17,00

They still come up regularly, the yoke first stage regulators, but don't worry we offer yoke nut sockets for several brands, including a 25mm socket for the Mares regulator service. If you are interested in multiple Mares scuba regulator tools, take a look at our Tool kits where we also offer a complete Mares regulator service kit, combine this with the necessary universal tools, and your Mares regulator service capabilities will not only increase but also run smoother.

MARES tools



Mares INT or yoke regulator AST tool

This tool opens and closes the Mares AST anti-infiltration technology for INT (yoke) first-stage connections.

The tool has a stainless steel handle for opening and closing by hand.

SKU: 2000-SST-010

€15,00



Mares inflator deflation button tool

The deflation button tool for the Mares inflator is used to remove and insert the small plastic ring together with its O-ring located in the bottom part of the inflator.

SKU: 1000-SST-050

€10,00

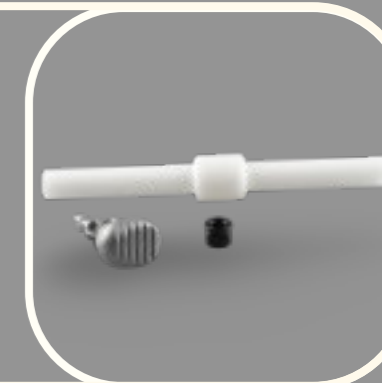

Mares DIN regulator AST tool

This tool opens and closes the Mares AST anti-infiltration technology for DIN first-stage connections.

The tool has a stainless steel handle for opening and closing by hand.

SKU: 2000-SST-011

€15,00



Mares HP valve seat tool

The Mares HP valve seat tool is used to remove and install the HP seat from the Mares first stage body.

SKU: 1000-SST-058

€11,00



Mares AIR control plug and exhaust valve cap tool

This tool is used to open and close the Mares AIR control inflator plug and exhaust valve cap.

SKU: 1200-SST-017

€12,00



Mares high-pressure seat removal tool

The Mares high-pressure seat removal tool is used to remove the high-pressure seat of the diaphragm first stage such as the MR22 and MR12.

SKU: 1200-SST-050

€7,00

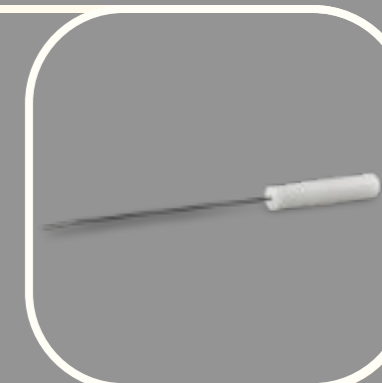

Mares demand lever valve and poppet tool

Putting the small steel rod and the HP seat in its place is a special job but by using the Mares demand lever valve and poppet tool it slides into place the right way.

The tool can also be used to install the demand lever of the second stage.

SKU: 1000-SST-054

€15,00



Mares high pressure seat tool

The Mares high-pressure seat tool is used for the installation of the HP seat. in several Mares' first stages.

SKU: 1000-SST-062

€10,00



Mares combined high pressure seat tool

Two tools for the price of one. With the combined HP seat tool for Mares, you can remove or assemble the HP seat in the Mares diaphragm first-stage body (12S, MR42, MR52).

With the other end of the tool, you can easily remove the HP seat

SKU: 1200-SST-049

€14,00



Mares case recovery tool

The Mares case recovery tool is used to save the plastic housings of several Mares second-stage regulator bodies when the valve body and the valve housing are badly corroded.

SKU: 2000-SST-005

€10,00



Mares adapter for hose protector tool

The Mares adapter for the hose protector tool is an add-on that can be used for Mares 1/2-inch hoses together with the universal hose protector tool.



SKU: 1240-SST-002

€10,00

Mares metal type regulator lever height tool

The Mares metal type regulator lever height tool can be used to adjust the lever height of the Mares metal type second stage regulators, as there are Abyss, Voltrex, Beta, Navy, and Ill.

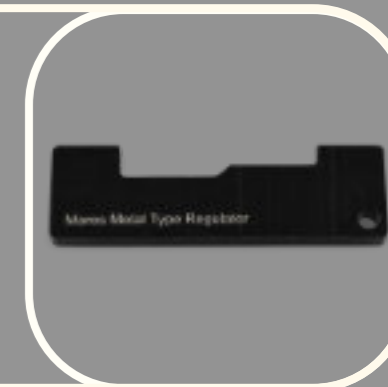

SKU: 1000-SST-074

€7,00

Mares 25mm yoke nut socket

This yoke nut socket of 25mm for Mares first stage with extra-thin walls fits on all Mares yoke international (INT) first-stage regulators.



SKU: 2000-SST-015

€19,99

Mares Turbo Flow lever height tool

The Mares Turbo Flow lever height tool can be used to adjust the lever height of the Mares second stages equipped with the Turbo Flow feature.



SKU: 1000-SST-075

€7,00

Mares MR12 guide bushing tool

The Mares MR12 guide bushing tool is used for the installation of the small parts on top of the spring in the first stage body of the Mares MR12.



SKU: 1000-SST-047

€13,00

Mares Air Control lever height tool

This Mares Air Control lever height tool is used for the final adjustment of the lever height in the Mares Air Control Octopus.

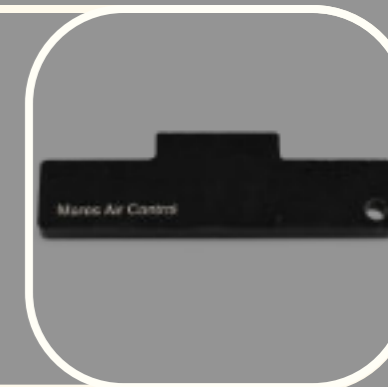

SKU: 1000-SST-076

€7,00

Mares second stage valve assembly tool

Mares second stage valve assembly tool used for installing the poppet assembly in the Mares second stage.



SKU: 1000-SST-052

€9,00

Power Inflator Tool for Mares XR and Poseidon Inflator

The Power Inflator Tool for Mares XR and Poseidon Inflator is used to remove and install the internal assembly as well as the inflator button.



SKU: 2000-SST-028

€19,00

Mares Technopolymer lever height tool

The Mares Technopolymer lever height tool can be used to adjust the lever height of the Mares Akros and Nikos second stage regulators.



SKU: 1000-SST-073

€7,00

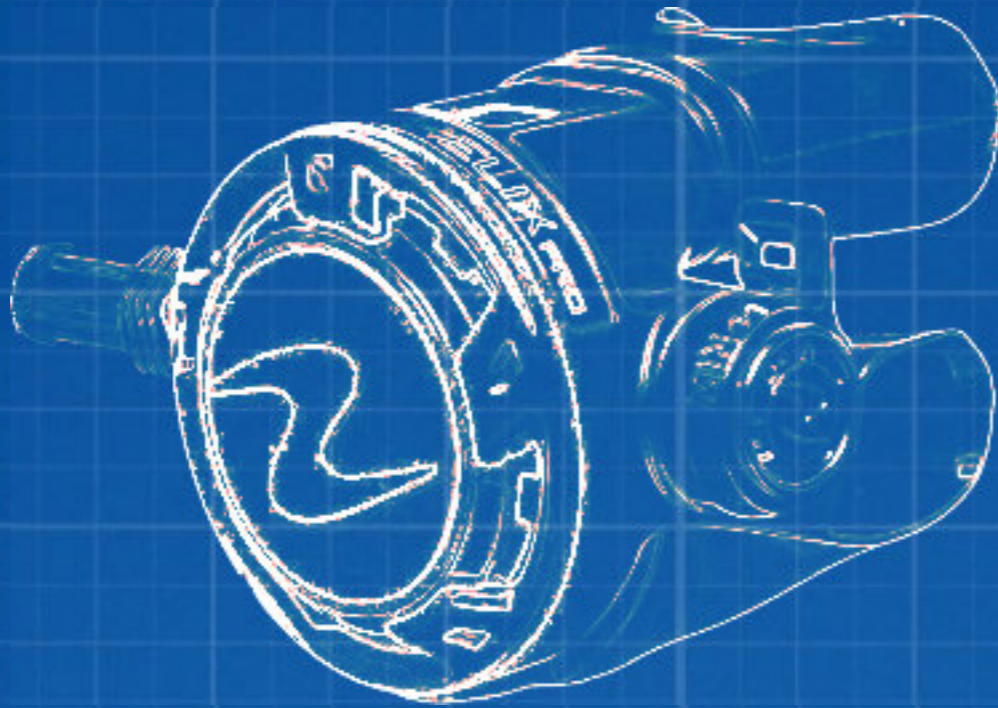

When you are busy with Aqualung regulator service and the service of Aqualung dive gear on a daily basis, various types of scuba regulators come along. In our online shop, we offer therefore a collection of Aqualung tools from the somewhat older Aqualung Conshelf to the much more current Aqualung Legend regulator which you can supplement with universal service tools and standard tools that are present in every workshop.

AQUALUNG tools

Aqualung Core cover tool

The cover tool for Aqualung Core second stage opens or closes the cover of the Aqualung Core second stage. Especially in situations where the ring holding the cover in place turns out to be too tight due to salt water corrosion or has been tightened too much.

SKU: 1000-SST-064

€14,00



Aqualung ABS octopus cover tool

The cover tool for Aqualung ABS octopus opens the cover of the Aqualung ABS octopus second stage.

SKU: 1000-SST-038

€16,00



Aqualung Legend I series and Titan LX cover tool

This cover tool for the Aqualung Legend I series opens not only the cover of the Aqualung Legend I series but also fits on the Titan LX second stage cover.

SKU: 1200-SST-015

€16,00



Aqualung Mikron cover tool

The cover tool for the Aqualung Mikron second stage is used to open and close the retaining ring from the second stage regulator during the Aqualung regulator service.

SKU: 1000-SST-030

€19,00



Aqualung diaphragm retainer tool for old models

The aqualung diaphragm retainer tool for old models is used to remove and install the round threaded diaphragm retainer ring.

SKU: 1000-SST-011

€13,00



Aqualung standard diaphragm retainer tool

The diaphragm retainer tool for Aqualung second stage is used to properly install and remove the threaded diaphragm retainer ring.



SKU: 1000-SST-001

€13,00

Aqualung Legend high pressure seat tool

The seat extractor tool for Aqualung first stage is used for installing and removing the HP seat of the Aqualung Legend first stage.



SKU: 1200-SST-007

€13,00

Aqualung Mikron diaphragm retainer tool

The diaphragm retainer tool for the aqualung Mikron is used to properly install and remove the threaded Aqualung diaphragm retainer ring of the Aqualung Mikron second-stage models during the Aqualung regulator service.



SKU: 1000-SST-029

€15,00

Aqualung power line inflator bezel tool

The bezel tool for Aqualung powerline inflators is used to install and remove the bezel of the Aqualung powerline inflator.



SKU: 1200-SST-009

€12,00

Aqualung guide bushing for Conshelf series

Installing all the small parts on top of the spring in the first stage body of the Aqualung Conshelf series is not an easy thing to do but this filter bushing tool for Aqualung first stage will help the parts slide into place and therefore give the technician room to put the circlip in its place.



SKU: 1000-SST-006

€8,00

Aqualung second stage setting tool

The setting tool for Aqualung second stage is used to set the optimal lever height for the Aqualung Calypso, Aqualung Titan, Aqualung Core, and the Aqualung Legend II second stage.



SKU: 1000-SST-049

€8,00

Aqualung dry chamber cap tool

The socket for Aqualung Titan dry chamber cap opens and closes the dry chamber ring on top of the following Aqualung/US Divers models: Titan, Conshelf, Cousteau, Sea, and Supra.



SKU: 3000-SST-006

€14,00

Aqualung T-Handle socket Titan LX, Kronos Core Supreme

The T-handle socket for Aqualung Titan LX Supreme, Kronos, and Core is used to open and close the diaphragm retainer / environmental cap of the Aqualung first stage. It does the job without scratching the surface of the first stage.



SKU: 1200-SST-008

€18,00

Aqualung 26mm yoke nut socket

This yoke nut socket 26mm with extra-thin walls fits on all Aqualung yoke (INT) first-stage regulators and the Apeks flight yoke (INT) first-stage regulator.



SKU: 2000-SST-013

€19,99

Aqualung lever height setting tool for balanced second

The lever Height setting tool for Aqualung balanced second stage can be used to adjust the lever height of several Aqualung second-stage.



SKU: 1000-SST-021

€7,00

Aqualung Titan LX high pressure seat tool

The Aqualung Titan LX high-pressure seat tool is used to remove and install the high-pressure seat from the housing of the Titan LX supreme first-stage body.

SKU: 1200-SST-060

€12,00



O-Ring tool for second stage barrel

The O-ring installation assist tool for Aqualung and Apeks balanced second stage barrel ensures that the O-rings from the Apeks service kit are not overstretched. By placing the tool over the barrel, the O-ring can easily be slid over it.

SKU: 1000-SST-014

€7,00



Aqualung Airsource 3 cover tool

The cover tool for Aqualung Airsource 3 second stage opens or closes the cover of the Aqualung Airsource 3 second stage.

SKU: 1000-SST-072

€19,00

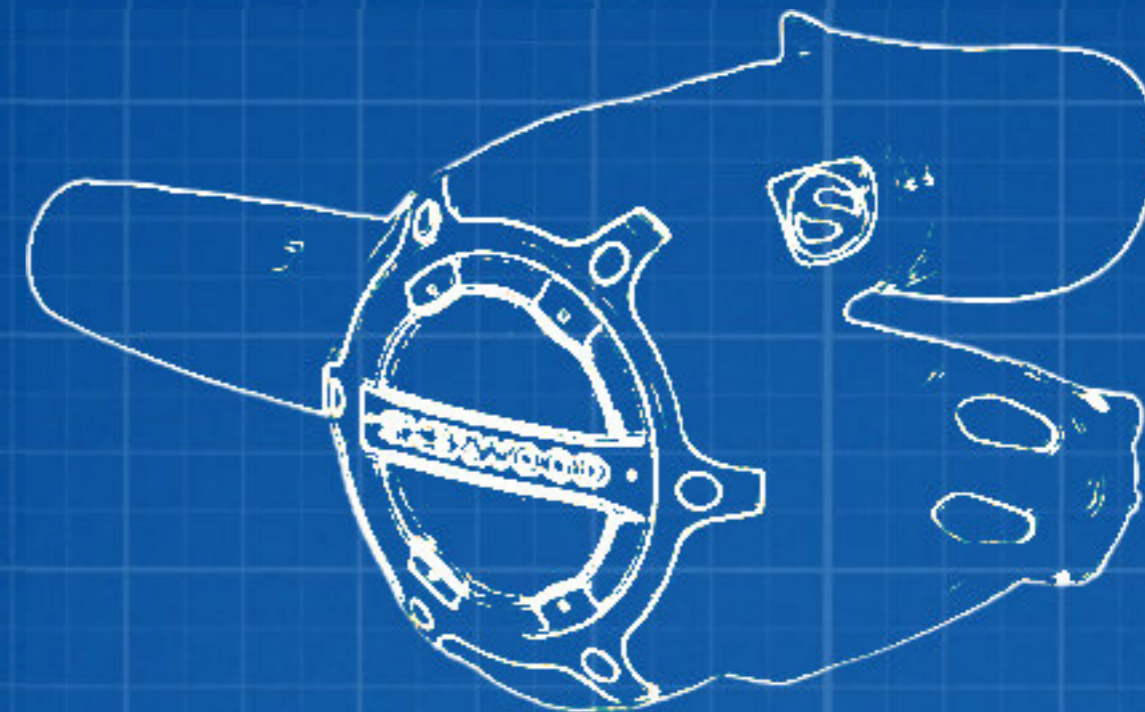

Specialized tools for Sherwood regulators



SHERWOOD tools

Sherwood SR series first stage diaphragm cap retainer

This specialized Sherwood scuba tool is used to open and close the diaphragm retainer cap from the Sherwood SR series first stage.



SKU: 1200-SST-014

€20.00

Sherwood environmental-cap tool

The three-pin socket for Sherwood first stage is used to open and close the environmental end cap of the Sherwood Magnum, Sherwood Brut, and the Sherwood SR1 first stage.



SKU: 3000-SST-001

€17,00

Sherwood SR series piston flange and seat retainer tool

This specialized tool is used to open and close the piston stem and flange of the Sherwood SR series first stage.



SKU: 2000-SST-006

€20,00

Sherwood SR series piston stem o-ring installation tool

Specialized tool to safely slide the o-rings over the threaded part of the Sherwood first-stage piston stem.



SKU: 1000-SST-016

€6,00

Sherwood SR series second stage poppet installation

This tool is used to easily install the Sherwood SR second stage poppet.



SKU: 1000-SST-019

€12,00

Sherwood SR series second stage cover retainer tool

Opening the Sherwood SR series second stage cover retainer tool is easiest by placing the tool with its tapers in the openings of the cover retainer ring.



SKU: 1000-SST-013

€16,00



Cressi XS cover tool

The Cressi XS cover scuba tool is used to open and close the cover of the Cressi XS second stage.



SKU: 1000-SST-067

€15,00

Cressi seal cap socket for MC7

Assemble and disassemble the older model seal cap socket on the Cressi MC7 model's first stage. The tool features a 1/2" Ratchet, allowing torque to be applied.



SKU: 1000-SST-010

€15,00

Cressi environmental seal cap socket

With the environmental seal cap socket for the Cressi first stage, you can assemble and disassemble the environmental seal cap on several Cressi first stages (MC7, MC9 S.C.).

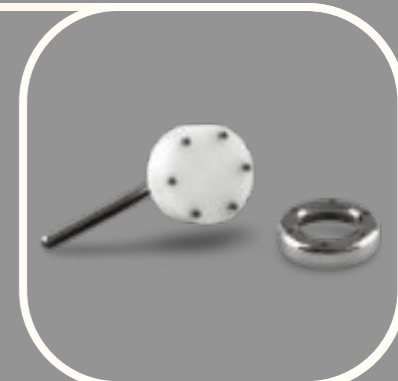

SKU: 1200-SST-004

€17,50

Scubapro 25mm yoke nut socket

This yoke nut socket 25mm for Scubapro first stage with extra-thin walls fits on all Scubapro yoke (INT) first-stage regulators. Also fits on several Cressi first stage.



SKU: 2000-SST-014

€19,99

Cressi MC9 High pressure seat extractor tool

The Cressi MC9 high-pressure seat extractor tool is used to remove and install the high-pressure seat from the Cressi MC9 first stage.

Material precision-machined from Acetal with stainless steel rod.



SKU: 1200-SST-046

€16,00

Our Cressi scuba tools are made with the highest precision from durable materials where possible we use high-quality plastics to prevent damage or scratches on your diving equipment.

You have to be able to rely completely on your diving equipment. It is therefore important to maintain and service it regularly. Maintenance of your diving equipment is a meticulous job. We, therefore, advise you to use one of our fine-tuning instruments after the Cressi regulator service.



CRESSI tools

Cressi T10 High-pressure seat extractor tool

The Cressi T10 high-pressure seat extractor tool is used to remove and install the high-pressure seat from the Cressi T10 first stage.

Material precision-machined from Acetal with stainless steel rod.

SKU: 1200-SST-045

€16.00

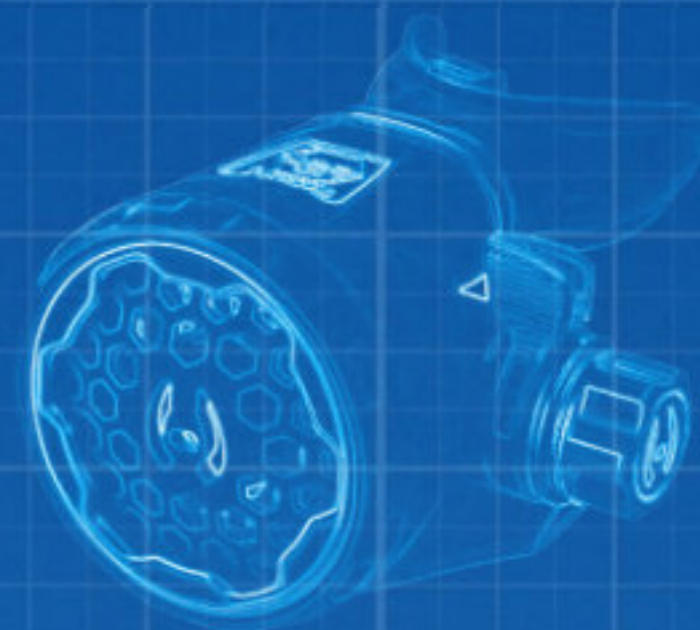
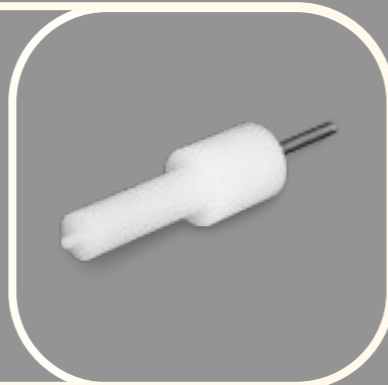

Our Hollis scuba tools are made with the highest precision from durable materials where possible we use high-quality plastics to prevent damage or scratches on your diving equipment.

You have to be able to rely completely on your diving equipment. It is therefore important to maintain and service it regularly. Maintenance of your diving equipment is a meticulous job. We, therefore, advise you to use one of our fine-tuning instruments after the Cressi regulator service.

HOLLIS tools



Hollis Aeris Oceanic FDXi diaphragm retainer end cap

This Hollis Aeris Oceanic FDXi diaphragm retainer end cap tool is designed to aid the service technician in the disassembly and assembly of the Oceanic FDXi first-stage diaphragm retainer end cap (part number 8373).



SKU: 1200-SST-012

€19,00

Hollis second stage diaphragm retainer tool

This diaphragm retaining ring tool for Hollis second stage can be used to unscrew or tighten the diaphragm retaining ring in balanced downstream Hollis second stage regulators such as the Hollis series 212, 221, and 321.



SKU: 1000-SST-075

€13,99

Hollis 6-pin environmental seal cap socket

This 6 pin 3/8" socket is used to open and close the environmental seal cap on the Hollis first stage.



SKU: 3000-SST-044

€19.99

1 Inch yoke nut socket

This 1 inch yoke nut socket fits on Oceanic, Hollis, Aeris, Dive Rite, and more yoke (INT) first-stage regulators. On this tool located at the top of the socket is an 8mm hex connection which is easily accessible with an 8mm long hex key with a connection to a 3/8" socket wrench.



SKU: 2000-SST-017

€19.99

Hollis LX series cover tool

The Hollis LX series cover tool is a must-have for any scuba enthusiast or service technician. This combination tool is specifically designed to make the installation and removal of the cover and diaphragm retainer ring of Hollis 100LX, 150LX, and 200LX second stages a breeze.



SKU: 1200-SST-043

€22,00

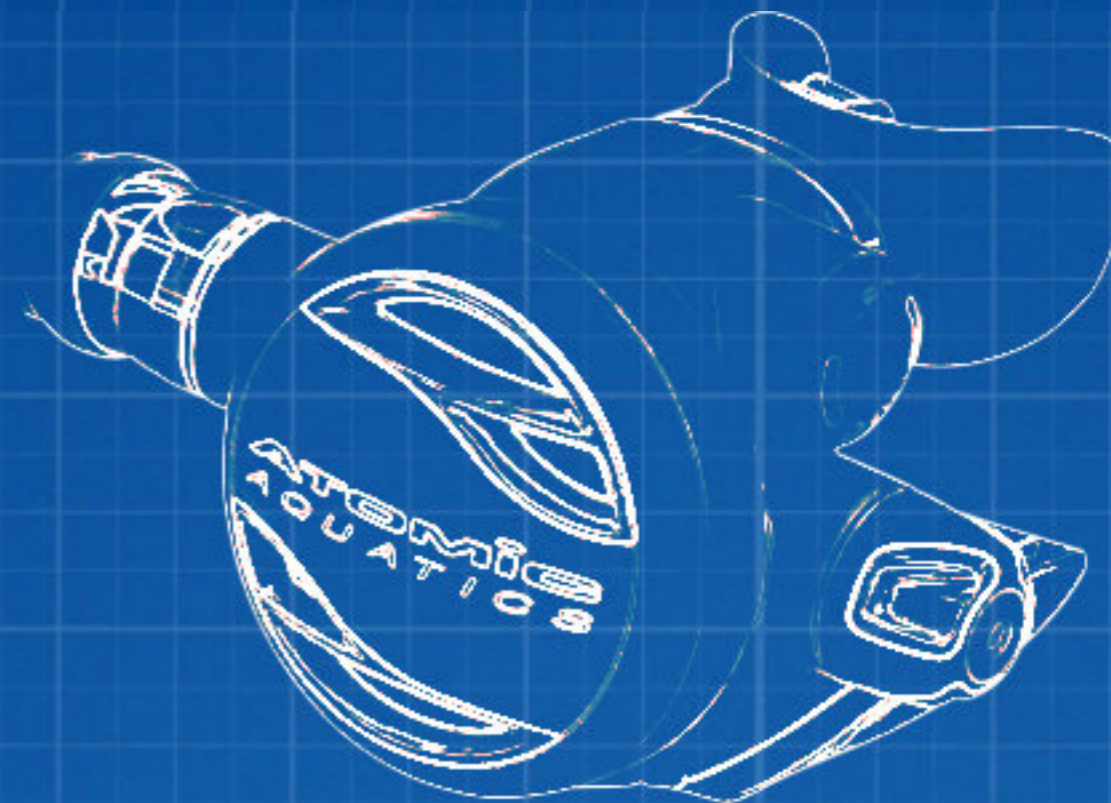

When it comes to being the best, Atomic Aquatics is driven by passion, precision and performance and so are we.

ATOMIC tools



Atomic second stage diaphragm retainer ring tool

The Atomic diaphragm retainer ring tool is used to properly install and remove the threaded diaphragm retainer ring of the Atomic second stage.



SKU: 1000-SST-073

€15,00

Atomic fist stage seat retainer socket

The seat retainer socket for Atomic first stage is used to remove and install the chrome seat retainer on the Atomic first stage.



SKU: 1000-SST-072

€12,00

1 Inch yoke nut socket

This 19mm yoke nut socket fits on Oceanic, Hollis, Aeris, Dive Rite, and more yoke (INT) first-stage regulators



SKU: 2000-SST-017

€19,99

Atomic first stage bushing tool

The Atomic first-stage bushing tool is designed for Atomic Aquatics first stages. This tool ensures the piston bushing assembly (Teflon washer, HP O-ring, and metal ring) is seated correctly.

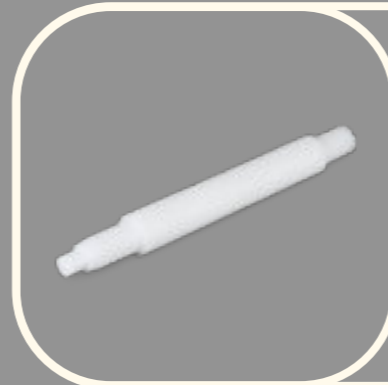

SKU: 1200-SST-041

€15,00

Atomic second stage AFC tool

The AFC tool for Atomic first stage is used to open and close the AFC cover on various Atomic Aquatics second stages.

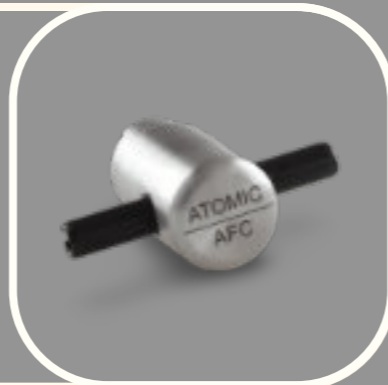

SKU: 3000-SST-005

€15,00

Atomic first stage piston tool

The piston bullet for Atomic first stage helps slide the piston assembly during the Atomic Aquatics regulator service through the first stage body while protecting the critical knife edge and preventing the o-ring from damage.



SKU: 4000-SST-010

€7,00

Atomic second stage poppet installation tool

The poppet installation tool for the Atomic second stage is used to align the second-stage poppet for proper installation into the second-stage barrel.



SKU: 3000-SST-007

€12,00

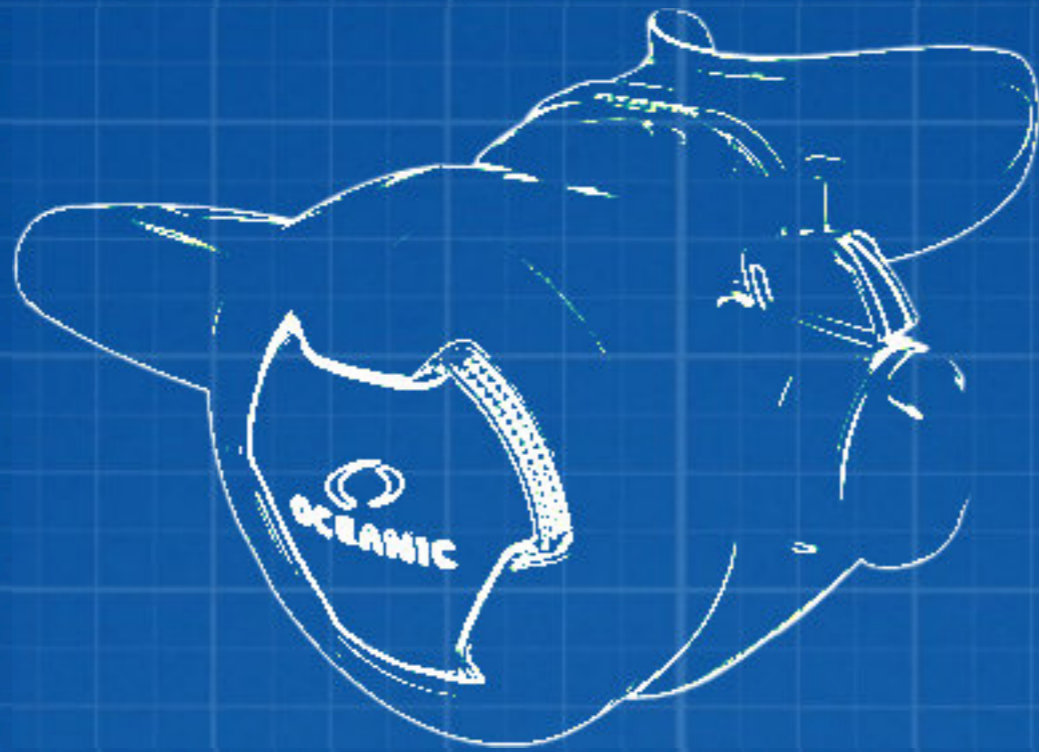

Oceanic FDXi diaphragm retainer end cap tool

This Oceanic FDXi diaphragm retainer end cap tool is designed to aid the service technician in the disassembly and assembly of the Oceanic FDXi first-stage diaphragm retainer end cap (part number 8373).



SKU: 1200-SST-012

€19,00



Oceanic quick release tool

The Oceanic quick-release coupler tool is used to disassemble and assemble the Oceanic quick-release coupler (A different size than the Suunto quick-release coupler tool).

SKU: 2000-SST-004

€25,00

Oceanic high-pressure seat tool

The high-pressure seat extractor for Oceanic first stage will assist the technician in removing and installing the high-pressure seat of Oceanic first stage.

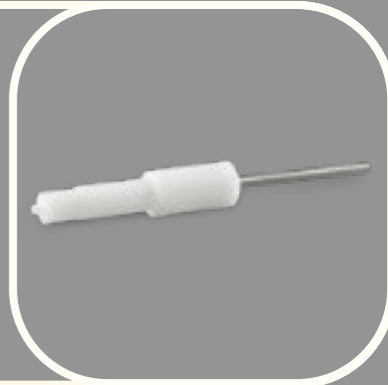

SKU: 1200-SST-006

€11,00



1 Inch yoke nut socket

This 19mm yoke nut socket fits on Oceanic, Hollis, Aeris, Dive Rite, and more yoke (INT) first-stage regulators

SKU: 2000-SST-017

€19,99

Specialized tools for Oceanic regulators

OCEANIC tools





Seac Sorius spring retainer ring tool

The cover tool for Apeks AT, T, TX and ATX will assist in the removal and installation of the second-stage cover of these Apeks second stage during the Apeks regulator service.



SKU: 4000-SST-001

€19,00

Specialized tools for Seac regulators

SEAC tools



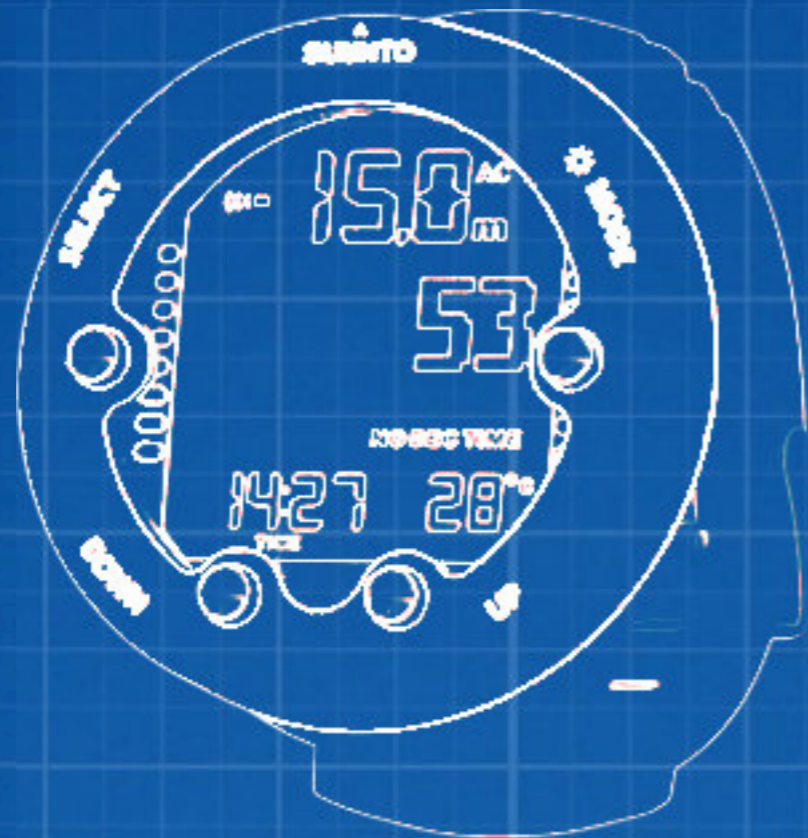

Suunto vise block for quick-release coupler

This block can be put in your vise to make the disassembly and assembly of the Suunto quick-release coupler a piece of cake. Because the block holds the Suunto quick-release coupler, the technician has both hands free to perform the service.



SKU: 1000-SST-068

€19,00



Suunto quick-release tool

The Disassembly and assembly of the Suunto quick-release coupler is best done with the Suunto quick-release tool.

SKU: 2000-SST-009

€29,00

Suunto quick-release coupler guiding pin

The Suunto quick-release coupler guiding pin is used to reinstall the O-rings on the Suunto quick-release coupler.

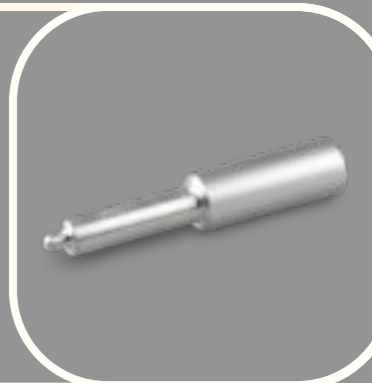

SKU: 2000-SST-055

€9,00

Specialized tools for Suunto regulators

SUUNTO tools





Universal scuba tools are the most important link in making your scuba service department complete whether you buy Scubapro tools, Apeks tools, or one of the other brands, there are always some universal tools and instruments needed to perform a complete scuba regulator service.

If you also want to adjust the regulator set to factory spec, we advise you to complete your range of tools with one of our scuba test benches

UNIVERSAL tools



Cylinder plug 3/4" X 14 NPSM

The 3/4" X 14 NPSM cylinder plug is an indispensable tool when tumbling or painting scuba cylinders.

SKU: 4000-SST-007

€12,00



Cylinder plug M25X2

The M25X2 cylinder plug is an indispensable tool when tumbling or painting scuba cylinders.

SKU: 4000-SST-005

€12,00



Thin spanner wrench 28mm and 13/16 inch

It is common during the service of a scuba regulator that there is not enough room to use 2 standard spanner wrenches.

To avoid this problem, we have designed thin spanner wrenches from high-quality 316 stainless steel.

SKU: 2000-SST-026

€24.00



Thin spanner wrench 19mm and 3/4 inch

It is common during the service of a scuba regulator that there is not enough room to use 2 standard spanner wrenches.

To avoid this problem, we have designed thin spanner wrenches from high-quality 316 stainless steel.

SKU: 2000-SST-025

€24.00



Thin spanner wrench 17mm and 11/16 inch

It is common during the service of a scuba regulator that there is not enough room to use 2 standard spanner wrenches.

To avoid this problem, we have designed thin spanner wrenches from high-quality 316 stainless steel.

SKU: 2000-SST-024

€24.00



Scubapro splined wrench

During the frequent use of this tool in our own service center, we have noticed that the splines in the aluminum and plastic version of this tool wear slowly and therefore no longer fit perfectly around the hose nut. To solve this problem, we redesigned the tool in a 304 stainless steel finish

SKU: 2000-SST-023

€14.99



Poppet tool for balanced second stages

The universal poppet installation tool for balanced second stage is used to install the poppet correctly into the barrel of the second stage (make sure the feet from the poppet are facing down before installation).

SKU: 1000-SST-012

€15,00



O-Ring pick set

This o-ring pick set has 6 different single and double-sided picking hooks. This allows it to handle almost any o-ring you might encounter during your regulator service.

SKU: 1800-SST-036

€9.00



Hose protector installation tool

The universal hose protector tool can be used to put hose protectors on low pressure or high pressure hoses. The tool can also be used to slide a console over the high pressure hose.

SKU: 1240-SST-001

€32,00

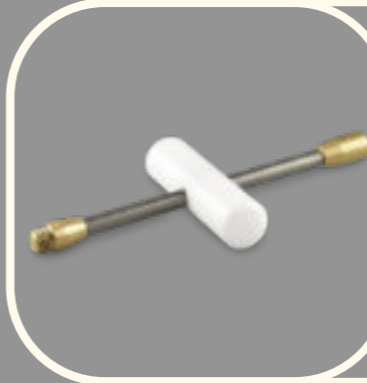

Cylinder valve installation and removal tool

The cylinder valve installation and removal tool assists with the removal or installation of the cylinder valve from a scuba cylinder.

SKU: 4000-SST-003

€39,00



Mares adapter for hose protector tool

The Mares adapter for the hose protector tool is an add-on that can be used for Mares 1/2-inch hoses together with the universal hose protector tool.

SKU: 1240-SST-002

€10,00



High pressure swivel tool

With the high-pressure swivel scuba tool putting the tiny O-rings on the high-pressure swivel is done in a matter of seconds without shooting the O-rings in all directions or losing the small metal swivel.

SKU: 1000-SST-046

€3.60



Poppet holder tool with 4 slots

Holding the poppet in position can be done with this second-stage poppet holder tool while the technician is screwing down the nylon nut. This tool fits poppets that have 4 tabs.

SKU: 3000-SST-011

€7,95

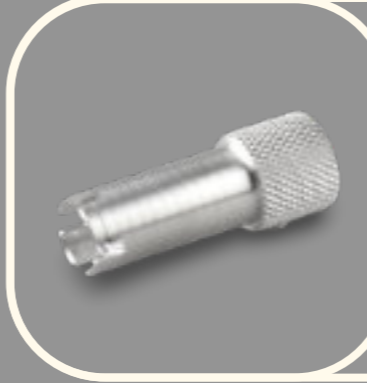

Inflator connector O-ring toolset

Installation of the O-ring in the low pressure inflator connector after service becomes a routine job with the universal inflator connector o-ring toolset.

SKU: 1000-SST-015

€16,50



Poppet holder tool with 3 slots

Holding the poppet in position can be done with this second-stage poppet holder tool while the technician is screwing down the nylon nut. This tool fits poppets that have 3 tabs.

SKU: 3000-SST-003

€7,95



Slotted cap driver tool

Use this slotted cap driver tool if you want to remove or install the slotted cap found on many first-stage brands.

because both ends have different sizes it fits on a wide variety of slotted caps.

SKU: 2000-SST-003

€14,40



DIN retainer tool

The DIN retainer tool is a lifesaver during the scuba regulator service, it is used for unscrewing the broken (rounded hex key) DIN connector of the first stage when a hex socket has no effect anymore because the opening has become completely round.

SKU: 3000-SST-043

€11,00



Cylinder valve handwheel tool

The cylinder valve handwheel tool is for the removal and installation of valve handwheel nuts and valve high-pressure seats.

SKU: 1200-SST-003

€19,00



Scubapro filter retainer mounting tool

The Scubapro filter retainer mounting tool installs the star washer on top of several Scubapro first-stage filters.

SKU: 3000-SST-022

€7,00



Power inflator tool

The power inflator tool is used to remove and install the internal assembly as well as the inflator button.

SKU: 2000-SST-057

€17,10



Orifice seat extractor tool

The Scuba Service Tools orifice seat extractor tool assists the technician during the regulator service with removing the orifice out of the second stage barrel or 2nd stage inlet fittings.

SKU: 1000-SST-061

€3,00



First-stage piston o-ring tool

The first-stage piston o-ring tool helps with the installation of the small O-ring on first-stage pistons.

SKU: 4000-SST-044

€9,00



O-ring installation tool set for HP and LP hoses

With the HP and LP O-ring installation tool-set, the technician can install the O-rings on low and high-pressure hose ends without damaging them.

SKU: 4000-SST-045

€12,00



Slotted orifice driver

The slotted orifice driver tool is used during regulator service for removing and installing the slotted orifice in many second-stage regulators.

SKU: 2000-SST-037

€14,00



First stage holder - heavy-duty version

The Heavy-duty first-stage holder has two different sides one is an LP with 3/8 UNF threads and the other one is an HP with 7/16 UNF threads.

The best way to use this tool is by clamping it in your vise so you have your hands free to work on your equipment.

SKU: 2000-SST-001

€17,00

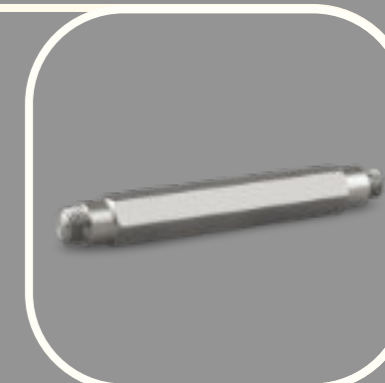

First stage holder

This tool is used to screw into the first stage so it can be gripped into a bench vise.

The first stage holder has two different sides one is an LP with 3/8 UNF threads and the other one is an HP with 7/16 UNF threads.

SKU: 2000-SST-056

€11,70

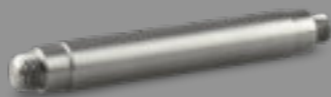

C-Spanner 1,4-inch

The 1,4-inch Custom-made C-spanner is used to remove and install environmental end caps as well as diaphragm clamps on several older Scubapro first-stage models.

SKU: 3000-SST-008

€19.00



High pressure seat extractor tool

Use the high-pressure seat extractor for first-stage tool for the extraction of high-pressure seats of the piston first-stage.

SKU: 1200-SST-039

€14,00



C-Spanner 1,5-inch

The 1,5-inch Custom-made C-spanner is used to remove and install environmental end caps as well as diaphragm clamps on several older Scubapro first-stage models.

SKU: 3000-SST-015

€19.00



Schrader valve stem tool

This tool is used to remove and install the Schrader valve from the BCD inflator.

SKU: 1800-SST-042

€9.00



C-Spanner 1,6-inch

The 1,6-inch Custom-made C-spanner is used to remove and install environmental end caps as well as diaphragm clamps on several older Scubapro first-stage models.

SKU: 3000-SST-010

€19.00



Magnetic vise jaws

100 mm Aluminium jaws with a v-groove will make sure you have a secure grip on the equipment being held in your vise.

SKU: 1800-SST-041

€24.00



C-Spanner 1,7-inch

The 1,7-inch Custom-made C-spanner is used to remove and install environmental end caps as well as diaphragm clamps on several older Scubapro first-stage models.

SKU: 3000-SST-014

€19.00



Air gun

Air gun with a connection to an air compressor.

SKU: 1800-SST-043

€12.00



Cylinder valve thread cleaning brush

Introducing our brass external thread cleaning brush designed specifically for scuba cylinder valves. This durable brush is perfect for keeping your equipment in top condition, ensuring a proper fit and seal every time.

SKU: 1200-SST-036

€7,00



Ultrasonic cleaner 2 liter (parts basket included)

- 135x150x100mm
- 2 liter
- Material stainless steel 220 volt

SKU: 1800-SST-060

€169.00



Thread cleaning brush set

Introducing our thread cleaning brush set, specifically designed for scuba cylinder threads. This set includes two brushes with diameters of 15mm brass (0.6 inches) and 22mm stainless steel (0.85 inches), perfect for cleaning the threads of your scuba cylinder and ensuring a secure seal.

SKU: 1200-SST-034

€15.00



GO scuba valve thread gauge for M25X2 external

Technical specifications This tool is used to check if the external threads of an M25X2 thread size scuba valve are still ok.

This is the GO version which means if it does fit on the threads that they are still ok.

SKU: 1800-SST-065

€119.00



Scuba cylinder thread gauge for M25X2 internal threads

Technical specifications This tool is used to check if the internal threads of an M25 thread size scuba cylinder are still ok. The tool has a go side and a no-go side.

SKU: 1800-SST-062

€119.00



GO scuba valve thread gauge for G3/4x14 external

Technical specifications This tool is used to check if the external threads of a G3/4x14 thread size scuba valve are still ok.

This is the GO version which means if it does fit on the threads that they are still ok.

SKU: 1800-SST-064

€139.00



Scuba cylinder thread gauge for G3/4x14 internal threads

Technical specifications This tool is used to check if the internal threads of a G3/4x14 thread size scuba cylinder are still ok. The tool has a go side and a no-go side.

SKU: 1800-SST-063

€139.00





Here you will find a collection of precision-picked scuba toolkits that are suitable for the home technician as well as regulator service shops.

Our scuba tool kits are composed in such a way that the most important tools are available for each manufacturer which can be supplemented with the purchase of individual specialized tools or individual tools from our universal tools collection. In this way, we prevent our customers from accidentally purchasing duplicate tools.

When putting together a scuba regulator service kit we have taken dive centers in mind and have ensured that the selection of tools is those they use most often in the daily service of scuba equipment. As your needs grow, you can easily upgrade your dive tool kit to suit your demands and other regulator tools.

TOOL-KITS



Thin spanner wrench set

Our line of thin spanner wrenches consists of the most commonly used metric and imperial sizes, To prevent the use of the wrong size wrench we have the sizes with the smallest difference in dimensions combined into one combination spanner wrench.

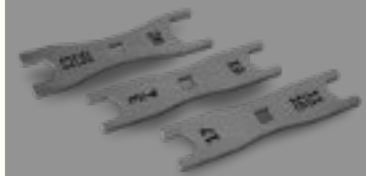

SKU: 2000-SST-027

€68.40

Yoke nut socket kit

The yoke nut socket kit consists of 4 yoke nut sockets and 1 retainer ring socket. It is the ideal kit In addition to the specialized tools kits. This complete set is 10% cheaper than buying all yoke nut sockets as separate items.



SKU: 2000-SST-019

€89,96

Scubapro AIR-2 tools set

This multi-toolset was developed for the regulator service of the Scubapro AIR-2 and Tusa Duo-AIR regulators.



SKU: 3000-SST-013

€55.00

Aqualung cover ring toolset

A nice collection of 4 Aqualung second-stage cover tools.

The Aqualung Cover Tool is an essential part of any technician servicing Aqualung diving equipment. It helps keep your second-stage regulator covers free of scratches if appropriately used.



SKU: 1800-SST-068

€58,50

Atomic tools kit starter edition

The Atomic tools starter kit consists of 6 specialized Atomic tools and is the ideal kit to start service on Atomic scuba gear.



SKU: 7000-SST-058

€69,00

Apeks cover ring tool set

The Apeks cover tool set is a nice collection of 3 Apeks second-stage cover tools. The Apeks cover tool is an essential part of any technician servicing Apeks diving equipment. It helps keep your second-stage regulator covers free of scratches if appropriately used.

SKU: 1800-SST-067

€42,00



Aqualung tools kit starter edition

The Aqualung tools starter kit consists of 10 specialized Aqualung tools and is the ideal kit to start service on Aqualung scuba gear.

SKU: 1800-SST-049

€105,80



Set of four C-spanners

The Custom-made C-spanners are used to remove and install environmental end caps as well as diaphragm clamps on first-stage regulators of several models.

SKU: 1300-SST-002

€69,00



Scubapro tools kit starter edition

The Scubapro tools starter kit consists of 13 specialized Scubapro tools and is the ideal kit to start service on Scubapro scuba gear.

SKU: 1800-SST-039

€126,65

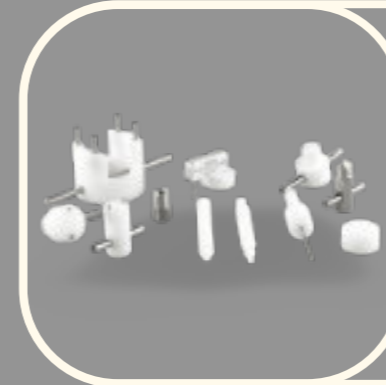

Scubapro cover tools kit

The Scubapro cover tools kit is a nice collection of 12 Scubapro second-stage cover tools that open an even bigger range of Scubapro second-stage regulators. With this set in your workshop, you will have more time for coffee after your Scubapro regulator service.

SKU: 1000-SST-041

€179,10



Mares tools kit starter edition

The Mares tools starter kit consists of 8 specialized Mares tools and is the ideal kit to start service on Mares scuba gear.

SKU: 1800-SST-040

€89,00



Scubapro AIR2 5th generation tools kit

This tool set is a collection of 7 tools needed to service a Scubapro AIR2 5th-generation regulator.

Note: For the service of the 5th generation AIR2, the service technician uses a number of tools that differ from the other generation AIR2 regulators

SKU: 1800-SST-066

€60,00



Poseidon tools kit starter edition

The Poseidon starter kit consists of 9 specialized Poseidon tools and is the ideal kit to start service on Poseidon scuba gear.

In addition to this set, we advise looking at our universal scuba tools.

SKU: 1800-SST-048

€139,12



Apeks tools-kit starter edition

This Apeks tools starter kit consists of 9 specialized Apeks tools and is the ideal kit to start service on Apeks scuba gear.

SKU: 1800-SST-078

€104,96



Universal tools kit basic edition

This Basic kit consists of 11 tools and is the ideal basic kit. In addition to the specialized tools kits, this complete set is 15% cheaper than buying all Universal tools as separate items.

SKU: 1800-SST-069

€95,00



Universal tools kit starter edition

The universal tools starter kit consists of 14 tools and is the ideal kit in addition to the specialized tools kits. This complete set is 10% cheaper than buying all Universal tools as separate items.



SKU: 1800-SST-044

€153,00

Mares tools kit deluxe edition

This Mares deluxe tools kit consists of 11 specialized Mares tools and is the ideal kit to start service on Mares scuba gear.



SKU: 7000-SST-036

€199,00



Suunto Quick release coupler tool-kit

With this toolset, you have all the tools and the vise block to service Suunto dive computers. You can place the quick-release coupler in the vise block so that you have both hands free to work on it.

SKU: 7000-SST-025

€49,00

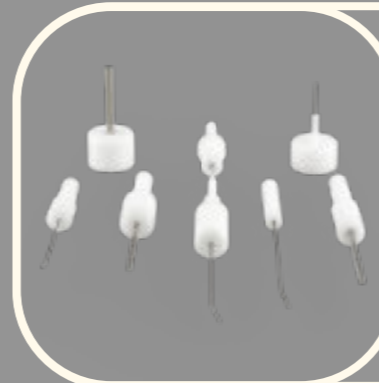

High pressure seat removal tools kit

A collection from several brands of high-pressure seat removal tools.

SKU: 1800-SST-047

€84,60

Apeks tools kit deluxe edition

This deluxe kit consists of 10 specialized Apeks tools and is the ideal kit to start service on Apeks scuba gear.



SKU: 7000-SST-035

€194,00

Aqualung diaphragm retainer tool set

This Aqualung diaphragm retainer tool set consists of a collection of all Aqualung diaphragm retainer tools.



SKU: 1800-SST-038

€36,90

Aqualung tools kit deluxe edition

The Aqualung deluxe tools kit consists of 13 specialized Aqualung tools and is the ideal kit to start service on Aqualung scuba gear.



SKU: 7000-SST-037

€226,90



Apeks drysuit tools set

This Apeks drysuit tools set consists of a collection of all Apeks drysuit tools needed to service the dump valve and the front and back of your drysuit inflator.

SKU: 1800-SST-037

€54,00

Scubapro tools kit deluxe edition

This Scubapro deluxe tools starter kit consists of 14 specialized Scubapro tools and is the ideal kit to start service on Scubapro scuba gear.



SKU: 7000-SST-038

€237,00

Apeks second stage lever height setting tools set

A collection of all Apeks lever height tools.



SKU: 1800-SST-032

€86,36

Scubapro C-series cover tool set

A collection of all Scubapro C-series cover tools.



SKU: 1800-SST-031

€32,40

Scubapro G-series cover tools set

The complete collection of second-stage cover tools that can be used during the service of the Scubapro G-series regulators.



SKU: 1800-SST-025

€49,50

Scubapro R series cover tool set

The complete collection of second-stage cover tools that can be used during the service of the Scubapro R series regulators.



SKU: 1800-SST-016

€99,00

Scubapro S-series cover tools set

A collection of all Scubapro S-series cover tools.



SKU: 1800-SST-010

€55,80

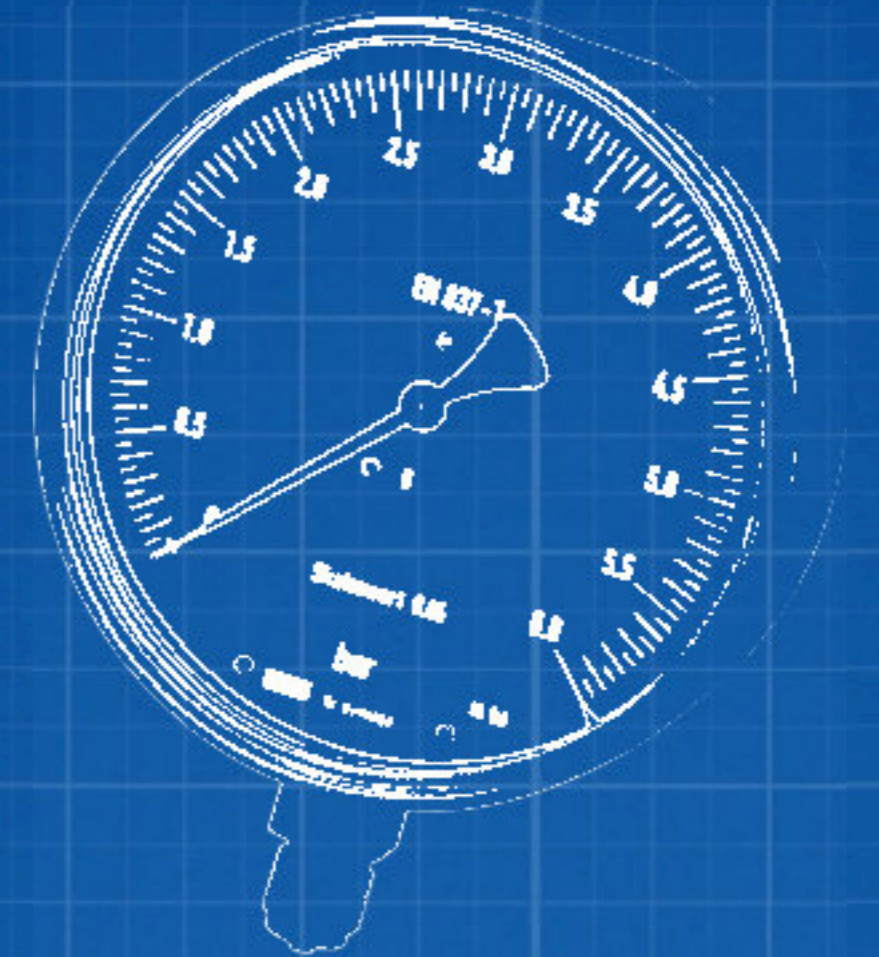

Check out our top-of-the-line test scuba test panels (available in four different versions) and other instrumentation and scuba adjustment tools.

Servicing a scuba regulator isn't something to be frivolous about, it's serious business and your customers expect to get back underwater safely.

To guarantee this safety, after the annual service, we recommend our customers to use a test bench when adjusting scuba first and second-stage regulators.

INSTRUMENTS



Scuba test bench - Resort version with big IP gauge

This scuba test bench lives up to its name, it does not require a connected air source and can therefore be used anywhere for the regulator service.

100mm / 3.95 inch intermediate pressure gauge.

SKU: 7000-SST-015

€399,00



Desk mounted Resort Test bench.

This test bench comes equipped with a big intermediate pressure gauge and a Magnehelic Meter, all neatly housed in a versatile mounting base. Made of durable black powder-coated 304 stainless steel, this test bench is built to last and withstand the rigors of daily use in a scuba service shop.

SKU: 7000-SST-014

€349.00



Scuba test bench - Resort version

This scuba test bench lives up to its name, it does not require a connected air source and can therefore be used anywhere for the regulator service.

63mm / 2.48 inch intermediate pressure gauge.

SKU: 7000-SST-013

€325,00



Desk mounted Intermediate pressure gauge

Introducing our desk-mounted intermediate pressure gauge, perfect for scuba testing and service equipment. This test bench comes equipped with a big intermediate pressure gauge neatly housed in a versatile mounting base. Made of durable black powder-coated 304 stainless steel.

SKU: 7000-SST-024

€275.00



Scuba test bench - Standard version

A must-have for the small operator that wants to service their own gear, it is equipped with a supply pressure gauge, a middle-pressure gauge with an inflator hose connection, and a Magnehelic meter to measure the cracking or inhalation effort.

SKU: 7000-SST-003

€449,00



Desk mounted Differential pressure gauge

This test bench comes equipped with a big differential pressure gauge, neatly housed in a versatile mounting base. Made of durable black powder-coated 304 stainless steel.

The convenient desk or wall-mount design allows for easy access and efficient use of space.

SKU: 7000-SST-020

€199.00



Scuba test bench - starter version

The starter version scuba test bench is a unique device that can be used to test scuba regulators at a basic level, it is equipped with a supply pressure gauge and a big middle-pressure gauge with an inflator hose connection both as well in BAR as in PSI.

SKU: 7000-SST-002

€299.25



Push-in connector for analog Magnehelic adaptor

Push-in connector for analog Magnehelic adaptor used on all of our test benches.

SKU: 7000-SST-060

€9,00



Scuba test bench - professional version

When dive gear service is your profession this "Professional scuba test bench" is your buddy.

SKU: 7000-SST-004

€1286,00



Wall mounted pipe clamp

6mm or 8mm wall mounted pipe clamp.

SKU: 7000-SST-059

SKU:7000-SST-065

€3,99



6mm pipe to 1/4NPT 90 degrees

6mm pipe to 1/4NPT 90 degrees with a maximum working pressure of 630Bar / 9100Psi.

Used on our professional test bench pressure regulator.

SKU: 7000-SST-061

€12.00

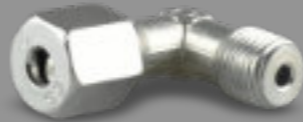

SLOTTED inline adjustment tool with gauge

The slotted in-line orifice adjustment tool with gauge connects in-line between the 2nd stage regulator and the LP hose, allowing adjustments while the hose is pressurized.

SKU: 1800-SST-052

€69.00



Manometer connection G1/4 to 6mm pipe

Manometer connection G1/4 to 6mm pipe with a maximum working pressure of 630Bar / 9100Psi..

SKU: 7000-SST-062

€15.00



HEX inline adjustment tool with gauge

The hex inline orifice adjustment tool with gauge connects in-line between the 2nd stage regulator and the LP hose, allowing adjustments while the hose is pressurized.

SKU: 1800-SST-074

€69.00



1/4G to 6mm plastic hose connector

1/4G to 6mm plastic hose connector used to connect our Magnehelic meter to the push in connector on the front of our test panels.

SKU: 7000-SST-063

€4,99

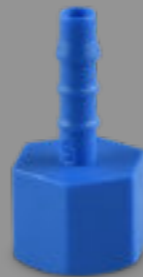

Digital Magnehelic meter

For measuring differential Pressure it is used to set up the inhalation effort for the second stage.

SKU: 1800-SST-053

€84.99



Analog Magnehelic hose connector

Analog Magnehelic hose connector used to push in our red hose which is used for the analog Magnehelic adapter.

This connector makes it possible to connect the adapter to one of our test benches

SKU: 7000-SST-064

€4,99



SLOTTED inline adjustment tool

The slotted in-line orifice adjustment tool connects in-line between the 2nd stage regulator and the LP hose, allowing adjustments while the hose is pressurized.

SKU: 1800-SST-075

€55.00



Spare rubber band seals for Magnehelic adapter

Two spare rubber band seals.

These seals connect the analog or digital Magnehelic mouthpiece adapters to a scuba regulator before testing.

SKU: 1800-SST-051

€14,00

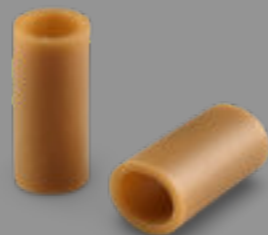

HEX inline adjustment tool

The hex inline orifice adjustment tool connects in-line between the 2nd stage regulator and the LP hose, allowing adjustments while the hose is pressurized.

SKU: 1800-SST-076

€55.00



300 bar/ 4800 psi DIN cylinder connection kit.

This DIN cylinder valve kit can be connected to a 300 bar / 4800 psi scuba cylinder.

It is often used to connect our Standard, Starter, or Professional test bench to an air source.

SKU: 7000-SST-046

€213.00



M25 bench mount

Our M25 bench mount is a very popular product at the many diving schools that we supply with our scuba tools, work with it once and you will never want to go anywhere else.

SKU: 7000-SST-010

€128.00



232 bar/ 3365 psi DIN cylinder connection kit.

This DIN cylinder valve kit can be connected to a 232 bar / 3365 psi scuba cylinder.

It is often used to connect our Standard, Starter, or Professional test bench to an air source.

SKU: 7000-SST-045

€149.00



Bench mount with M25 valve 232 Bar

This bench mount can be attached to your work surface and equipped with an M25 scuba valve, it can be connected to the scuba regulator to be serviced. The bench mount can be connected as a stand alone to a scuba cylinder, but of course also in combination with one of our test benches.

SKU: 7000-SST-012

€179.00



Test bench analog Magnehelic adapter

The test bench analog Magnehelic adapter has been specially developed to be used in combination with our test bench. It comes with a special connector that fits on the Magnehelic meter connection on all of our test benches equipped with this device.

SKU: 7000-SST-009

€22,50



M25 cylinder valve

M25 cylinder valve for Bench mount

SKU: 7000-SST-057

€69.00

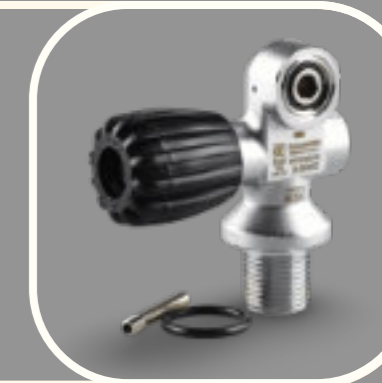

Intermediate pressure gauge for inflator hose

A compact 1.5 in or 3.8 cm diameter ultra-lightweight dual-scale PSI and BAR intermediate pressure gauge

This pressure gauge is ready to go with you anywhere. Perfect for helping diagnose problems in the field, it plugs into any standard BC low-pressure inflator hose.

SKU: 1800-SST-054

€25.00



232 bar / 3365 psi DIN cylinder connection valve

This DIN cylinder valve can be connected to a scuba cylinder.

It is often used to connect our Standard, Starter, or Professional test bench to an air source.

SKU: 7000-SST-017

€99.00



Mouthpiece adapter for digital Magnehelic meter

This universal mouthpiece adapter is used to connect the second-stage regulator (when the mouthpiece is removed) to a digital Magnehelic meter used for setting up or checking the cracking effort of a second-stage regulator during the scuba regulator service.

SKU: 1000-SST-003

€19,00



300 bar / 4800 psi DIN cylinder connection valve

This DIN cylinder valve can be connected to a scuba cylinder.

It is often used to connect our Standard, Starter, or Professional test bench to an air source.

SKU: 7000-SST-018

€128.00

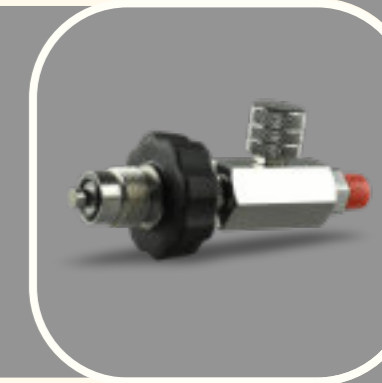

Bench mount connection kit

The Bench mount connection kit is the ideal add-on for the Standard or Professional test bench.

SKU: 7000-SST-016

€266.00



G1/4 male to G1/8 male connector

G1/4 male to G1/8 male both sides are 60 degrees conical.

SKU: 7000-SST-006

€14.00



Professional Test bench connection kit (6mm pipe)

This Professional test bench connection kit can be used to connect the Professional test bench with the use of stainless steel piping to an air source.

SKU: 7000-SST-007

€235.00



G1/4 male to G1/4 male connector

G1/4 male to G1/4 male both sides are 60 degrees conical.

SKU: 7000-SST-008

€14.00



Microbore hose

This hose can be used to connect all of our test benches to an air source (scuba cylinder) and the M25 bench mount.

The micro bore hose has an extra thin diameter and a maximum working pressure of 400Bar/5800Psi with a length of 1meter / 3,3 feet.

SKU: 7000-SST-011

€35.00



Blind stop for bench mount

Blind stop for side or bottom of bench mount.
Connection male G-1/4 with 6mm HEX insert.

SKU: 7000-SST-005

€12.00



G1/4 female to 6mm pipe connection

G1/4 female to 6mm pipe connection, mostly used to connect our test benches to 6mm stainless steel pipe.

SKU: 7000-SST-039

€12.00



6mm pipe blind stop

Blind stop for the side of a test bench when no M25 bench mount is connected.

SKU: 7000-SST-055

€4.99



1/4G female to pipe connector

Connection female G-1/4 to 6mm pipe.

SKU: 7000-SST-034

€15.00



6mm pipe straight connector

Straight connector needed for the blind stop for the side of a test bench when no M25 bench mount is connected.

SKU: 7000-SST-056

€9.00



Pressure tester for dive computers

Pressure testing dive computers and small scuba dive lights.

MORE INFO ON NEXT PAGE....

SKU: 1200-SST-026

€1299.00



Dive computer pressure test chamber

Pressure testing dive computers and small scuba dive lights.

Every dive shop/service center naturally wants to hand over its customers a properly sealed dive computer after service, and they certainly don't want to see a customer return from their next dive with a flooded computer.

Worry-free dive computer servicing

After replacing batteries and/or O-rings from a dive computer, this is the ideal way to check for leaks.

Using the Scuba Service Tools dive computer pressure chamber, the computer is safely pressurized and then submerged in water. This allows small air bubbles to escape from the computer during the venting process if a leak occurs.

This method of testing does not damage the dive computer because only air can enter, instead of water.

Dive computers and small dive lights can be tested safely with the Scuba Service Tools pressure tester without damaging your customers' expensive equipment.

- Maximum working pressure 8 bar / 116 Psi
- Height 540 mm / 21.25 inch
- Tube inner diameter 140 mm / 5.51 inch

Package includes:

- Pressure tester
- Control panel
- Tube to connect the tester to the control panel



SKU: 1200-SST-026

€1299.00

Pressure tester for dive computers

Dive computers and small dive lights can be tested safely with the Scuba Service Tools pressure tester, without damaging your customers' expensive equipment.



SKU: 1200-SST-026

€1299.00

Set of four E-clamps

A set of four E-clamps used to hold the side rod assistance ring in place.



SKU: 1200-SST-029

€4.00

Manual pressure release valve

Our pressure tester is standard equipped with a manual pressure release valve.

It releases the pressure by opening or closing the screw on top of the valve



SKU: 1200-SST-027

€24.00

Set of Teflon spacer rings

Spare set of Teflon spacer rings for the dive computer pressure tester.

This set of spare Teflon spacer rings contains all the spacer rings used in the dive computer pressure tester.

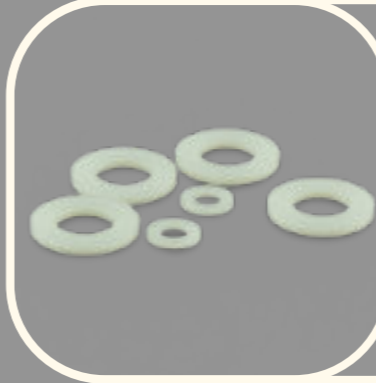

SKU: 1200-SST-030

€5.00

Knop for lift rod

Knob for the lift rod used to lower the lift plate down.

The knob has an M6 internal thread.



SKU: 1200-SST-031

€14.00

Silencer for manual pressure release valve

A silencer for the manual pressure release valve is used to reduce the sharp sound when venting the dive computer pressure tester.



SKU: 1200-SST-028

€5.00

Knop for top plate

Knob for the top plate so that it can be closed evenly at four points.

The knob has an M12 internal thread.



SKU: 1200-SST-025

€14.00

Connection tube

Blind stop for the side of a test bench when no M25 bench mount is connected.



SKU: 1200-SST-022

€7.00

Ball valve

Ball valve for pressure tester control panel

Connection G1/4 female



SKU: 1200-SST-024

€12.99

Set of O-rings

Spare set of O-rings for the dive computer pressure tester.

This set of spare O-rings contains all the O-rings used in the dive computer pressure tester.

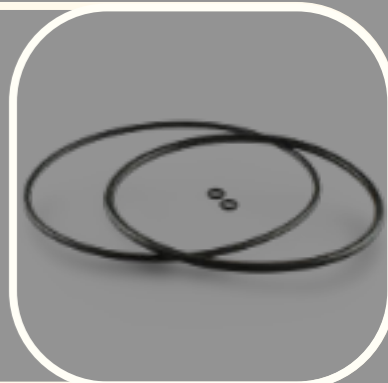

SKU: 1200-SST-023

€24.99

Drysuit leak testing control panel

Pressure testing drysuits after changing seals or during service.

Ensure your scuba drysuits are in top condition with the Scuba Service Tools leak testing control panel. This essential tool is perfect for testing drysuit seals after changes or during your annual service.

With its user-friendly interface, you can quickly identify leaks and maintain the integrity of your equipment.

The drysuit tester features an AIR-IN connector located on the side, along with two AIR-OUT connectors positioned on the top. Users can regulate the air entering the drysuit through the fast and slow AIR lever. Additionally, a pressure regulator allows for fine-tuning of the incoming air to ensure optimal performance during checks.



- Maximum working pressure 6 bar / 87 Psi
- Measurements WxDxH 295mm/11,61inch X 142,05mm/5,59inch X 128mm/5,04inch
- Diferential pressure gauge 0-10 inch H2o

Shipping time depends on the delivery time of the Magnehelic meter from the US.

SKU: 1200-SST-048

€649.00

Drysuit leak tester connection hose

Drysuit leak tester connection hose

Length 2 meters / 787 inches



SKU: 1200-SST-053

€36,00

Set of two drysuit leak tester connection hoses

Set of two drysuit leak tester connection hoses

Length 2 meters / 787 inches



SKU: 1200-SST-052

€59,00

Drysuit sleeve cone

The drysuit sleeve cone is used to connect the drysuit to the leak tester control panel.



SKU: 1200-SST-054

€95,00

Northern diver drysuit exhaust/inflator back plate tool

The Northern diver drysuit exhaust and inflator back plate tool is used to remove and install the back plate from the Northern Diver automatic dump valve and the swivel inflator back plate from the Northern Diver drysuits.



SKU: 1200-SST-058

€31.00

Si-Tech and Bare drysuit inflator/exhaust back plate tool

The Si-Tech and Bare drysuit inflator and exhaust back plate tool is used to remove and install the back plate from the Si-Tech and Bare automatic dump valve and the swivel inflator back plate from the Si-Tech and Bare drysuits.



SKU: 1200-SST-055

€29.00

Si-Tech and Bare drysuit exhaust tool

The Si-Tech and Bare drysuit exhaust tool is used to remove the cap of the Si-Tech and Bare automatic dump valve located on the arm of the drysuit.



SKU: 1200-SST-056

€29.00

Si-Tech and Bare drysuit inflator tool

The Si-Tech and Bare drysuit inflator tool is used to separate the valve body of the Si-Tech and Bare swivel inflator valve from your drysuit so you can reach the o-rings for inspection inside the swivel body



SKU: 1200-SST-057

€29.00

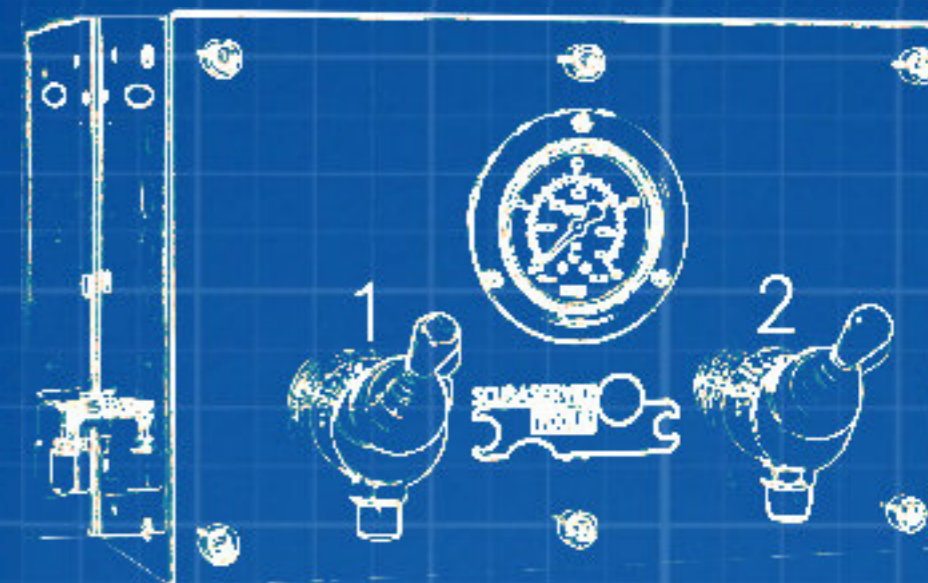

Scuba Service Tools fill/charging panels and bank storage panels are used by small dive shops and major dive operators around the world. Due to the high demand, we have now also made them available in our webshop.

At the moment we have a choice of 2 different scuba filling panels and 1 Air bank/scuba cascade panel which can be supplemented as desired with options such as charging hoses and different cylinder charging connectors.

All our panels are made of high-quality stainless steel and are precisely tailored on a CNC press brake

FILL PANELS



Scuba fill panel with 2 ports

The 2 port air charging panel (200 bar / 3000Psi) is ideal for small dive shops or private use, as well as paintball clubs.

The unit has 2 charging points (max 232Bar / 3000Psi) and a manometer and can fill two scuba cylinders at the same time.

SKU: 7000-SST-022

€899.00



Cylinder charging hose (for charging panel)

The cover tool for Apeks AT, T, TX and ATX will assist in the removal and installation of the second-stage cover of these Apeks second stage during the Apeks regulator service.

SKU: 7000-SST-030 1meter €149.00

SKU: 7000-SST-031 1,5meter €159.00

SKU: 7000-SST-033 2meter €169.00



Cascade panel

The Scuba cascade panel is ideal for dive shops, clubs, schools, and medium-sized breathing air-filling stations.

The unit can connect 3 storage tanks (max 300 bar / 4350 psi) and a charging panel.

SKU: 7000-SST-023

€1599.00

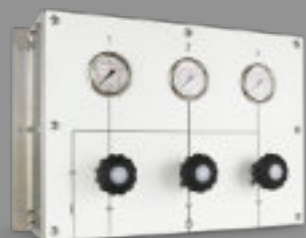

Scuba fill panel with 4 ports

The 4 port charging panel is ideal for dive shops, dive clubs, and dive schools, as well as medium-sized breathing air-filling stations.

The unit can fill 200 Bar/3000 Psi as well as 300 Bar/4500 Psi scuba cylinders.

SKU: 7000-SST-021

€2199.00

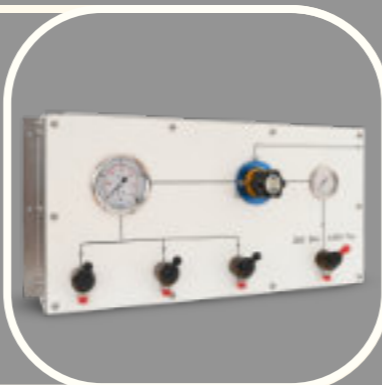

1/4G female to pipe connector

Connection female G-1/4 to 6mm pipe.

SKU: 7000-SST-034

€15.00



300Bar / 4500Psi cylinder charging connector

300 Bar / 4500 Psi cylinder charging connector

Connects between the filling hose and a 300 Bar / 4500 Psi scuba cylinder.

SKU: 7000-SST-028

€44.00



Wall mounted ball valve

Wall-mounted ball valve G1/4 female to G1/4 female

SKU: 7000-SST-033

€69.00



200Bar / 3000Psi cylinder charging connector

200 Bar / 3000 Psi cylinder charging connector

Connects between the filling hose and a 200 Bar / 3000 Psi scuba cylinder.

SKU: 7000-SST-029

€36.00



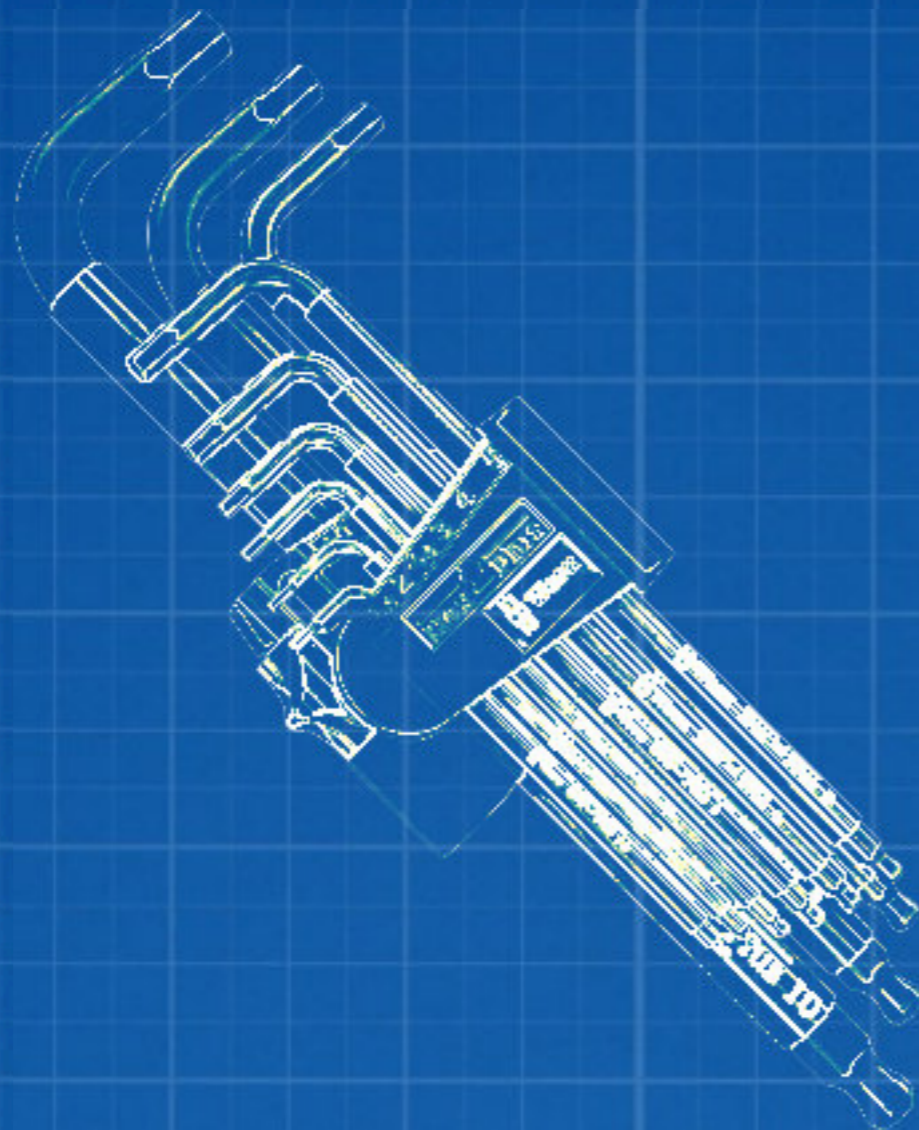

Standard hand tools should not be missing in the scuba technician workshop and because we do not manufacture these tools in-house, we have chosen tools from the best German hand tool manufacturers such as Wera, Knipex, Gedore, and Stahlwille.

Among our hand tools, you will find various types of tweezers and face tensioners.

But also the sockets and wrenches are widely represented in Metric and Imperial sizes which are standard in the scuba industry.

STANDARD TOOLS



Torque wrench 5-25 NM

This high-quality torque wrench has a working range of 5-25 Nm. The connection is a 1/4" drive.



SKU: 1800-SST-011

€89.00

Wera extra long Torx set

Premium L-key set for TORX® socket screws. One arm extra long. Includes some tools with ball head: The ball on the long arm allows safe working even in difficult installation positions. L-keys with plastic sleeves made of circular, easy-grip material.

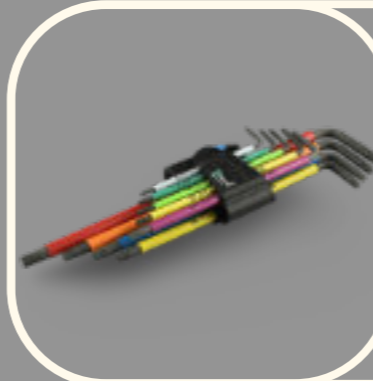

SKU: 1800-SST-072

€49.00

Wera extra long imperial Hex set

High-quality L-key set for imperial hexagonal socket screws in a practical clip fastener out of wear-resistant material, enabling secure storage of the L-keys as well as simple removal.



SKU: 1800-SST-071

€38.00

Wera extra long metric Hex set

L-keys with plastic sleeves (SPKL) made of circular, easy-grip material. The sleeve makes working comfortable even at low temperatures and is easy on the fingers. All L-keys are easily accessible due to their colour coding and size markings.



SKU: 1800-SST-070

€45.00

Ultrasonic cleaner 2 liter (parts basket included)

Ultrasonic cleaner 2 liter (parts basket included)



SKU: 1800-SST-060

€169.00

Wera Bitholding screwdriver with a strong magnet

High quality Wera Bitholding screwdriver with strong permanent magnet that holds the bits absolutely securely. Kraffform handle for pleasant, ergonomic working.

Suitable for bits with 1/4" hexagon head drive

SKU: 1800-SST-079

€26.00



Wera torx HF screwdriver TX10 with holding function

Premium Wera torx HF screwdriver with holding function for precision mechanical couplings. By supporting the hand on the rotating cap and due to the fast rotating zone below the rotating cap, lightning-fast turning is possible.

Shaft length 60mm / 2 3/8inch

SKU: 1800-SST-057

€14.99



Wera kraffform micro nut driver 5.5 - 60 mm

Premium Wera Kraffform micro nut driver 5.5 - 60 mm for precision mechanical couplings. By supporting the hand on the rotating cap and due to the fast rotating zone below the rotating cap, lightning-fast turning is possible.

Shaft length 60mm / 2 3/8inch

SKU: 1800-SST-058

€15.99



Wera torx HF screwdriver TX6 with holding function

Premium Wera torx HF screwdriver with holding function for precision mechanical couplings. By supporting the hand on the rotating cap and due to the fast rotating zone below the rotating cap, lightning-fast turning is possible.

Shaft length 40mm / 1. 9/16inch

SKU: 1800-SST-080

€14.99



Wera kraffform micro nut driver 1/4" - 60 mm

Premium Wera Kraffform micro nut driver 1/4" for precision mechanical couplings. By supporting the hand on the rotating cap and due to the fast rotating zone below the rotating cap, lightning-fast turning is possible.

Shaft length 60mm / 2 3/8inch

SKU: 1800-SST-073

€15.99



Wera Kraffform PH-00 Screwdriver for Phillips screws

Premium Wera Kraffform PH-00 Screwdriver for Phillips screws for precision mechanical couplings. By supporting the hand on the rotating cap and due to the fast rotating zone below the rotating cap, lightning-fast turning is possible.

Shaft length 60mm / 2 3/8inch

SKU: 1800-SST-082

€14.99



Wera screwdriver for slotted screws

Premium Wera screwdriver for slotted screws for precision mechanical couplings. By supporting the hand on the rotating cap and due to the fast rotating zone below the rotating cap, lightning-fast turning is possible.

Point width 3,5mm / 1/32inch Shaft length 80mm / 1 9/16inch

SKU: 1800-SST-056

€14.99



Wera Kraffform PH-0 Screwdriver for Phillips screws

Premium Wera Kraffform PH-00 Screwdriver for Phillips screws for precision mechanical couplings. By supporting the hand on the rotating cap and due to the fast rotating zone below the rotating cap, lightning-fast turning is possible.

Shaft length 60mm / 2 3/8inch

SKU: 1800-SST-059

€14.99



Wera torx HF screwdriver TX5 with holding function

Premium Wera torx HF screwdriver TX5 with holding function for precision mechanical couplings. By supporting the hand on the rotating cap and due to the fast rotating zone below the rotating cap, lightning-fast turning is possible.

Shaft length 40mm / 1. 9/16inch

SKU: 1800-SST-081

€14.99



Wera Kraffform PH-1 Screwdriver for Phillips screws

Premium Wera Kraffform PH-00 Screwdriver for Phillips screws for precision mechanical couplings. By supporting the hand on the rotating cap and due to the fast rotating zone below the rotating cap, lightning-fast turning is possible.

Shaft length 60mm / 2 3/8inch

SKU: 1800-SST-061

€14.99



Extra long straight nose tweezers

These extra-long straight-nose tweezers have the following specs:
Made of stainless steel, Equipped with heat-resistant handles.
Acid-resistant and anti-magnetic. Straight mouth.

SKU: 1800-SST-046

€4.99



Adjustable face spanner 2mm

This tool is something a technician can't do without, it can be used for several different brands and parts of diving gear.
Pin size is 2mm

SKU: 1800-SST-009

€19.00



Pointed-tip tweezers

Gripping and handling small objects is a necessity for many professionals. With these tweezers, you can gently grip even very small objects, making them easier to edit or move.

SKU: 1800-SST-024

€4.99



Yoke-nut tool Knipex Pliers Wrench

replaces the need for sets of metric and imperial spanners
smooth jaws for damage-free installation of plated fittings - working directly on chrome!

adjustable tightening tool

SKU: 1800-SST-033

€89.00



Bend nose tweezers

The bend nose tweezers with curved tips provide a better view of work in sorting, assembling, and positioning small parts.

SKU: 1800-SST-015

€4.99



Wrench 32mm

Single Open End Wrench 32mm.

Material: Vanadium steel, manganese-phosphated.

SKU: 1800-SST-027

€13.00

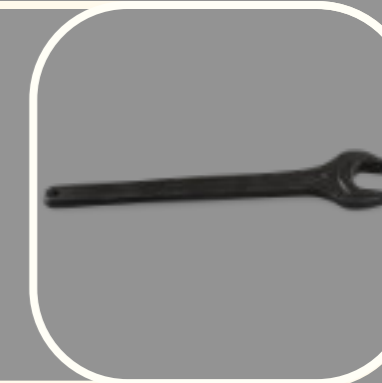

35 to 60mm Adjustable C spanner

35 to 60mm Adjustable hook spanner to be used for almost all brands to install or remove 1st stage regulators caps.

Pin size diameter: 3,7mm

SKU: 1800-SST-035

€39.00



Wrench 34mm

Single Open End Wrench 34mm.

Material: Vanadium steel, manganese-phosphated.

SKU: 1800-SST-028

€13.00



Adjustable face spanner 1,5mm

This tool is something a technician can't do without, it can be used for several different brands and parts of diving gear.

Pin size is 1,5mm

SKU: 1800-SST-034

€19.00



1/4" male inside to 3/8" outside adapter

1/4" male inside to 3/8" outside adapter to be used with our torque wrench.

SKU: 1800-SST-012

€15.00



PH-1 Philips screwdriver

PH-1 Philips screwdriver



SKU: 1800-SST-018

€13.00

3/8" to hex 1/4"

Hex 1/4 inch key with connection to 3/8 inch Socket Wrench
1st class quality tool from the German brand Stahlwille.



SKU: 1800-SST-001

€25.00

PH-0 Philips screwdriver

PH-0 Philips screwdriver



SKU: 1800-SST-017

€13.00

3/8" to hex 5/32"

Hex 5/32" key with connection to 3/8" Socket Wrench
1st class quality tool from the German brand Stahlwille.



SKU: 1800-SST-004

€25.00

Screwdriver slotted

Screwdriver slotted with wrench attachment.



SKU: 1800-SST-019

€13.00

3/8" to hex 7/32"

Hex 7/32" key with connection to 3/8" Socket Wrench
1st class quality tool from the German brand Stahlwille.

Ideal to remove the swivel retainer of the Scubapro MK25 & MK10 first stages.



SKU: 1800-SST-003

€25.00

Wera Screwdriver rack empty

"Customize" your Wera kraftform micro Screwdriver rack. Create your own micro screwdriver rack filling.



SKU: 1800-SST-079

€12.99

3/8" to Torx 30

Torx 30 key with connection to 3/8" Socket Wrench
1st class quality tool from the German brand Stahlwille.

To remove the torx screws out of the cap from the Scubapro MK21 first stage.



SKU: 1800-SST-008

€19.00

3/8" to hex 8mm long

Hex 8mm long key with connection to 3/8" Socket Wrench
1st class quality tool from the German brand Stahlwille.



SKU: 1800-SST-007

€19.00

3/8" to hex 5mm long

Hex 5mm long key with connection to 3/8" Socket Wrench
1st class quality tool from the German brand Stahlwille
Fits on some of the Mares first stage regulators.

SKU: 1800-SST-005

€19.00



Bent nose pliers

Bent nose pliers

SKU: 1800-SST-022

€17.00



3/8" to hex 6mm long

Hex 6mm long key with connection to 3/8" Socket Wrench 1st class quality tool from the German brand Stahlwille.

This is one of the most used hex keys in a divers workshop it fits on the DIN inlet fittings of most brands: Scubapro, Apeks, Aqualung, Dive Rite, Mares and many more.

SKU: 1800-SST-006

€19.00



Wrench 1/4"

Combination wrench 1/4" Ideal when taking of or putting on second stage poppet nuts.

Material: Chrome-vanadium steel from German brand Gedore

SKU: 1800-SST-026

€14.00



Side cutters, Stainless steel

Side cutters, Stainless steel

SKU: 1800-SST-020

€14.99



Wrench 9/16" to 5/8" for scuba hoses

Wrench imperial sizes of 9/16" to 5/8"

This wrench fits on about 85% of all scuba hoses and therefore it is the ideal wrench to have in your scuba gear bag.

SKU: 1800-SST-055

€17.50



Internal Circlip Pliers

Internal Circlip Pliers

SKU: 1800-SST-023

€17.00



Wrench 3/4" to 13/16"

Wrench 3/4" to 13/16

Fits on most older Aqualung second stages.

SKU: 1800-SST-029

€23.00



Flat nose pliers

Flat nose pliers

SKU: 1800-SST-021

€17.00



Wrench 5/8 to 11/16"

Wrench imperial sizes of 5/8" to 11/16" This wrench fits ideal on Apeks and Aqualung second stages.

Material: Chrome-vanadium steel from the German brand Stahlwille

SKU: 1800-SST-030

€19.00



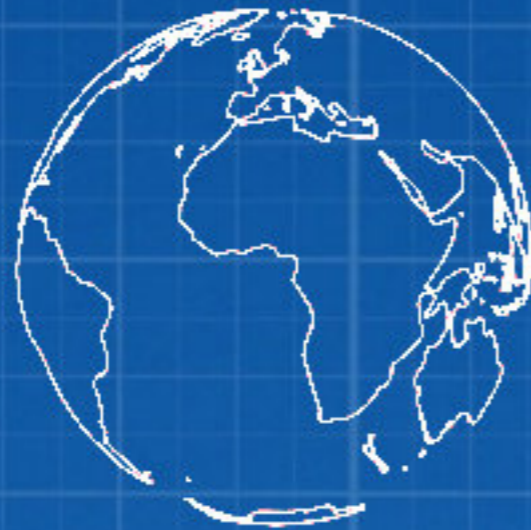

**WE SHIP
WORLDWIDE**

Fast and reliable shipping to any destination world wide.

SHIPPING



Webshop (retail only): After filling your basket in our webshop the total of your shipping expenses is automatically calculated at check-out, based on the shipping weight and destination.

Our goods are packed in boxes or padded envelopes to make sure your goods are reaching their destination without damaging.

Dealer conditions:

- Ordering by e-mail only
- Use our SKU codes for your order and send it by e-mail to info@divingondemand.com
- Companies inside the EU but outside The Netherlands can receive an invoice without VAT if provided full company details and a registered EU VAT number.
- To make sure your invoice is without VAT, please provide us with all company information in your e-mail.

We offer free shipping on orders over €250.

A number of countries are not covered by this offer. Whether your country qualifies for free shipping will be visible during checkout, here you can choose the option "Standard tracked €0.00"

